



*Products for the Construction Industry*





## Ingersoll Rand... On the job for more than a century

Ingersoll Rand has a unique heritage in construction that dates back to the company's founding in 1871. Simon Ingersoll invented the world's first rock drill and revolutionized productivity on the jobsite with the wide array of compressors, tools, and related products that came later. He built a business and an industry with the power and tools that helped create such wonders as Hoover Dam and Mt. Rushmore.

Today, Ingersoll Rand offers one of the most comprehensive lines of construction tools available, as well as portable air compressors that have become industry standards. As a full-line tool and equipment provider, Ingersoll Rand also offers service and maintenance tools such as Impacttools™ and surface preparation tools, as well as pullers, hoists, and winches for material handling tasks. Ingersoll Rand is breaking new ground with solutions for the jobsite, backed by a solid history, proven performance, and strong customer support. Go to [irtools.com](http://irtools.com) or call an Ingersoll Rand representative at (800) 376-TOOL for complete details.

Construction Tools



3

Air Compressors



16

Service and Maintenance Tools



20

Hoists and Winches



35

# Construction Tools



Pavement Breakers	5
Spike Drivers	7
Diggers	7
Pavement Breaker and Digger Steels	8
Jackhammers and Rockdrills	9
Steels, Bits, and Retainers	9
Rivet Busters	10
Rivet Buster Steels and Retainers	10
Chipping Hammers	11
Chipping Hammer Steels and Retainers	13
Backfill Tampers and Sand Rammers	14

**Ergonomically designed** handles, grips, throttle lever, and breaker housing provide maximum operator comfort and productivity

**Internal lubricator** for continuous tool protection

**Four-bolt backhead** contoured to fit operator's leg; easily removed for routine maintenance

**Drop-in valve cartridge** simplifies maintenance and reduces overall operating costs

**Power-Strok™ piston cycle** transfers blow energy directly to the tool, improving productivity

**Variable exhaust deflector** rotates 360°, allowing the operator to choose the direction of the exhaust air

**One-piece breaker housing** eliminates the need for side rods and springs — and fewer parts means lower operating costs

**Patented anvil bushing** eliminates the need for an anvil block while delivering smooth operation, superior control, and unsurpassed breaking power

# 30% fewer parts

Ingersoll Rand breaker



Competitive brand breaker



## Pavement Breakers



PB35AL8



PB35AS8

## PB Series

- ▶ One-piece housing eliminates costly side rods and springs
- ▶ Power-stroke piston delivers more energy to the work surface and eliminates another costly wear item
- ▶ Built-in lubricator helps ensure adequate lubrication
- ▶ Two roll pins and removal of the housing plug on the top head make service access simple
- ▶ Muffler reduces noise (PB35AS8 and PB50AS1 only)



PB50AL1



PB50AS1

Model	Hex Shank Size	Stroke in (mm)	Bore in (mm)	Length Without Accessory in (mm)	Weight Without Accessory lb (kg)	bpm	cfm	Inlet Size NPT in	Recommended Hose Size in (mm)
<b>PAVING BREAKERS WITH MUFFLER</b>									
PB35AS8	1" x 4-1/4"	6.25" (159)	1.75" (44)	25" (625)	43 (20)	1,250	49	3/4"	3/4" (19)
PB50AS1	1-1/8" x 6"	6.25" (159)	1.75" (44)	27.5" (699)	55 (25)	1,150	58	3/4"	3/4" (19)
<b>PAVING BREAKERS WITHOUT MUFFLER</b>									
PB35AL8	1" x 4-1/4"	6.25" (159)	1.75" (44)	25" (625)	40 (18)	1,250	49	3/4"	3/4" (19)
PB50AL1	1-1/8" x 6"	6.25" (159)	1.75" (44)	27.5" (699)	52 (24)	1,150	58	3/4"	3/4" (19)

Performance figures are at 90 psi (6.2 bar) air pressure.

## MX Series

- ▶ No expensive side rods and springs
- ▶ Composite valve won't rust
- ▶ Directional exhaust eliminates blow back
- ▶ Built-in lubricator
- ▶ Hand-serviceable shank doesn't require a press to service
- ▶ Backhead conforms to operator's leg
- ▶ Optional muffler sold separately (MX90 Series only)



MX60A



MX90A

## MX Series with Flex-Handle™

- ▶ The Flex-Handle feature provides vibration dampening in a full 360° range of movement. Competitive mechanical springs only work in one direction and lose their ability to absorb vibration when fully compressed, or when hammering while pulling the breaker out of the work surface.



MX60AF



MX90AF

Model	Hex Shank Size	Stroke in (mm)	Bore in (mm)	Length Without Accessory in (mm)	Weight Without Accessory lb (kg)	bpm	cfm	Inlet Size NPT in	Recommended Hose Size in (mm)	Muffler Part Number
<b>STANDARD BREAKERS</b>										
MX60A	1-1/8" x 6"	5.75" (146)	2.06" (52.3)	27.5" (686)	76 (31.8)	1,250	70	3/4"	3/4" (19)	N/A
MX60B	1-1/4" x 6"	5.75" (146)	2.06" (52.3)	27.5" (686)	76 (31.8)	1,250	70	3/4"	3/4" (19)	N/A
MX90A	1-1/8" x 6"	5.75" (146)	2.62" (66.5)	27.5" (686)	87 (39.5)	1,250	85	3/4"	3/4" (19)	51953453
MX90B	1-1/4" x 6"	5.75" (146)	2.62" (66.5)	27.5" (686)	87 (39.5)	1,250	85	3/4"	3/4" (19)	51953453
<b>VIBRATION-REDUCED FLEX-HANDLE BREAKERS</b>										
MX60AF	1-1/8" x 6"	5.75" (146)	2.06" (52.3)	27.5" (686)	76 (31.8)	1,250	70	3/4"	3/4" (19)	N/A
MX60BF	1-1/4" x 6"	5.75" (146)	2.06" (52.3)	27.5" (686)	76 (31.8)	1,250	70	3/4"	3/4" (19)	N/A
MX90AF	1-1/8" x 6"	5.75" (146)	2.62" (66.5)	27.5" (686)	87 (39.5)	1,250	85	3/4"	3/4" (19)	51953453
MX90BF	1-1/4" x 6"	5.75" (146)	2.62" (66.5)	27.5" (686)	87 (39.5)	1,250	85	3/4"	3/4" (19)	51953453

Performance figures are at 90 psi (6.2 bar) air pressure.

## Spike Drivers

- ▶ Built-in lubricator
- ▶ No side rods or springs to wear
- ▶ Composite valve eliminates rust
- ▶ Power-stroke piston
- ▶ The fronthead guides and supports spike



MX60-SD

MX90-SD

Model	Stroke in (mm)	Bore in (mm)	Length Without Accessory in (mm)	Weight Without Accessory lb (kg)	bpm	cfm	Inlet Size NPT in	Recommended Hose Size in (mm)
<b>FIXED-SPIKE DRIVERS</b>								
MX60-SD	5.75" (146)	2.06" (52.3)	27.5" (686)	69 (31.4)	1,250	70	3/4"	3/4" (19)
MX90-SD	5.75" (146)	2.62" (66.5)	27.5" (686)	86 (39)	1,250	85	3/4"	3/4" (19)
<b>VIBRATION-REDUCED FLEX-HANDLE MODELS</b>								
MX60F-SD	5.75" (146)	2.06" (52.3)	27.5" (686)	69 (31.4)	1,250	70	3/4"	3/4" (19)
MX90F-SD	5.75" (146)	2.62" (66.5)	27.5" (686)	86 (39)	1,250	85	3/4"	3/4" (19)

Performance figures are at 90 psi (6.2 bar) air pressure.

## Diggers

- ▶ Multiple retainer configurations
- ▶ D-handle grip
- ▶ Extra long nozzles for long life
- ▶ Three-finger inside trigger



93LA1















95LA1

Model	Retainer Type	Hex Shank Size	Stroke in (mm)	Bore in (mm)	Length Without Accessory in (mm)	Weight Without Accessory lb (kg)	bpm	cfm	Inlet Size NPT in	Recommended Hose Size in (mm)
<b>93 SERIES LIGHTWEIGHT DIGGERS</b>										
93A1	Sleeve	7/8" x 3-1/4"	2.5" (64)	1.69" (43)	18.88" (479)	22 (10)	2,350	45	3/8"	1/2" (13)
93A4	Hitch	7/8" x 3-1/4"	2.5" (64)	1.69" (43)	17.88" (454)	21 (9.5)	2,350	45	3/8"	1/2" (13)
93LA1	Latch	7/8" x 3-1/4"	2.5" (64)	1.69" (43)	18.88" (479)	23 (10.4)	2,350	45	3/8"	1/2" (13)
<b>95 SERIES MEDIUM-WEIGHT DIGGERS</b>										
95A1	Sleeve	7/8" x 3-1/4"	4" (102)	1.69" (43)	21.88" (556)	27 (12.3)	1,850	47	3/8"	1/2" (13)
95LA1	Latch	7/8" x 3-1/4"	4" (102)	1.69" (43)	21.88" (556)	28 (12.7)	1,850	47	3/8"	1/2" (13)
95LA3	Latch	1" x 4-1/4"	4" (102)	1.69" (43)	21.88" (556)	30 (13.6)	1,850	47	3/8"	1/2" (13)

Performance figures are at 90 psi (6.2 bar) air pressure.



## Pavement Breaker and Digger Steels

Product	Steel Description	Under Collar		Hex Shank Size and Part Number			
		Length	Tool*	7/8" x 3-1/4"	1" x 4-1/4"	1-1/8" x 6"	1-1/4" x 6"
	Moil Points — Standard-duty <i>Used for general demolition</i>	14"	PB / D	50050269	50050368	50050475	50055680
		18"		50050277	50050376	50055524	50055698
		24"		50050285	50050392	50055540	50055714
		36"		51305860	45512563	50055565	50055730
		48"		45512621	45512571	50055573	50055748
		60"		45512639	45512589	50055581	50055755
	72"	45512647	45512597	50055599	50198993		
	Moil Points — Super-duty	11-1/4"	PB / D	22041495	22041057	22041073	22041099
		14-1/4"		22041602	22041065	22041081	22041107
		1" Narrow Chisels — Standard-duty <i>Used for general demolition</i>	14"	PB / D	50199207	50197805	50197904
18"			50199215		50197821	50197912	50196401
24"			50199223		45510245	50197938	50196419
36"			45510682		45510252	51298107	51299477
48"			45510690		45510260	50197979	51299485
60"			45510708		45510278	50197987	51299048
72"		45510716	45510286	50197995	51299493		
1" Narrow Chisels — Super-duty		11-1/4"	PB / D	22041503	22041115	22041131	22041156
		14-1/4"		22041610	22041123	22041149	22041164
		1-1/2" Super-cut Chisel <i>Specially designed for breaking concrete</i>	16"	PB	N/A	22040463	22040471
	3" Chisels <i>Used for concrete demolition and asphalt cutting</i>	14"	PB	50195288	50195320	50114883	50193879
		18"		50195296	50195338	50193754	50193887
		24"		45510542	50195353	50193747	50193903
		36"		45510559	50195361	45510500	45510484
		48"		45510567	50195379	45510518	50193937
		60"		45510575	45510476	45510526	45510492
72"	45510583	51304574	45510534	50191790			
	3" Digging Chisel <i>Used for deeper digging and asphalt cutting</i>	16"	D	22040968	22040976	22040984	5018604
	3-3/4" Combo Cutter <i>Used for manhole reconstruction</i>	11-1/2"	PB	N/A	N/A	22040612	22040620
	5" Asphalt Cutter <i>Used for asphalt cutting and removal</i>	11"	PB	22040935	50190404	50185982	50185990
	5-1/2" Clay Spade <i>Used for trench digging and trimming</i>	11"	D	50189596	50189554	50189562	50189570
	1" Pipe Drivers <i>Used for driving steel pipe with up to 1-1/2" OD</i>	11"	PB	N/A	N/A	22040505	22040513
	1-1/2" Pipe Drivers	11"	PB	N/A	N/A	22040547	22040554
	Ground Rod Driver <i>Used for driving steel rod with up to 1" OD</i>	8"	PB	N/A	22040588	22040596	22040604
	Detachable Shank <i>To be used with tent stake drivers or tamping pad</i>	7-3/4"	PB / D	22040927	50187830	50187848	50187855
	2" Tent Stake Drivers <i>Used with detachable shank</i>	N/A	PB / D	22040638	22040638	22040638	22040638
	2-1/2" Tent Stake Drivers	N/A	PB / D	22040646	22040646	22040646	22040646
	8" Tamping Pad Square <i>Used for tamping and backfilling; used with detachable shank</i>	N/A	PB / D	50187897	50187897	50187897	50187897
	3-piece Sign Post Driver <i>Includes shank, post block, and 3-1/2" IO driver</i>	7-3/4"	PB / D	22040778	22040943	22041008	22041016

\*PB = Pavement Breaker  
D = Digger

Super-duty moil points and chisels are rounded under the collar and have more mass and strength for longer life and less sharpening. Other steels and lengths available from Ingersoll Rand Construction Tool Steels and Accessories Catalog: Form # IRPS-0407-006.

## Jackhammers and Rockdrills

- ▶ Easy-access adjustable 3-speed throttle
- ▶ Reversible pawls
- ▶ Integral muffler
- ▶ For wet or dry drilling

JRD30-A

JH40C2

JRD50

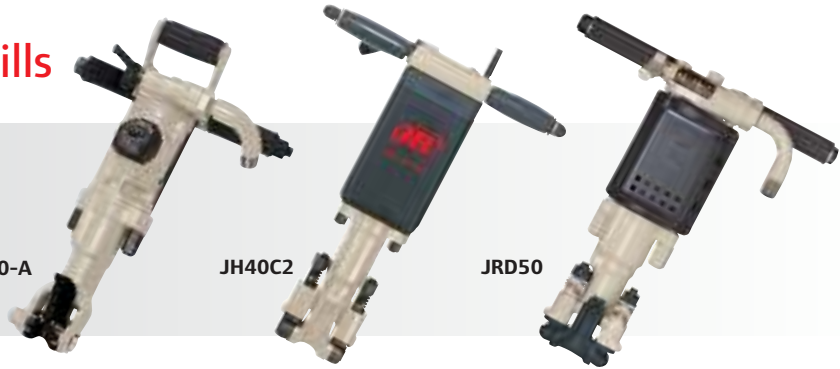



Model	Hex Shank Size	Stroke in (mm)	Bore in (mm)	Length Without Accessory in (mm)	Weight Without Accessory lb (kg)	Max Hole Diameter	Max Hole Depth	bpm	cfm	Inlet Size NPT in	Recommended Hose Size in (mm)
JRD30-A	7/8" x 3-1/4"	1.44" (37)	2.38" (60)	19.5" (495)	29 (13.2)	1.5" (38)	10' (254)	2,700	73	3/4"	3/4" (19)
JRD30-B	7/8" x 4-1/4"	1.44" (37)	2.38" (60)	19.5" (495)	29 (13.2)	1.5" (38)	10' (254)	2,700	73	3/4"	3/4" (19)
JH40C1	7/8" x 3-1/4"	2.63" (67)	2.5" (63.5)	22.5" (572)	61 (27.7)	2" (51)	18' (457)	2,000	115	3/4"	3/4" (19)
JH40C2	7/8" x 4-1/4"	2.63" (67)	2.5" (63.5)	22.5" (572)	61 (27.7)	2" (51)	18' (457)	2,000	115	3/4"	3/4" (19)
JH40C3	1" x 4-1/4"	2.63" (67)	2.5" (63.5)	22.5" (572)	61 (27.7)	2" (51)	18' (457)	2,000	115	3/4"	3/4" (19)
JRD50-A	7/8" x 3-1/4"	2" (51)	3" (76)	20.5" (521)	51 (23)	2" (51)	16' (406)	2,300	120	3/4"	3/4" (19)
JRD50-B	7/8" x 4-1/4"	2" (51)	3" (76)	20.5" (521)	51 (23)	2" (51)	16' (406)	2,300	120	3/4"	3/4" (19)
JRD50-C	1" x 4-1/4"	2" (51)	3" (76)	20.5" (521)	51 (23)	2" (51)	16' (406)	2,300	120	3/4"	3/4" (19)

Performance figures are at 90 psi (6.2 bar) air pressure.

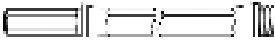
## Steels, Bits, and Retainers

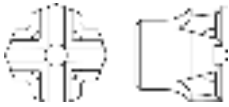
Product	Description	Under Collar Length in			
		7/8" x 3-1/4"	7/8" x 4-1/4"	1" x 4-1/4"	
	"H" Thread Jack Rods	18"	50283266	51242014	50713031
		24"	50283506	51233690	50354596
		30"	51305639	51242030	51305704
		36"	50712728	51234052	50713049
		48"	50283555	51234060	50283183
		60"	50712736	51242063	50713056

Product	Description	Bit Size in (mm)	Part Number	
			Single-use	Multi-use
	"H" Thread Carbide Bits	1-1/2" (38)	51248367	51248300
		1-3/4" (44)	51248383	51248326
		2" (52)	51248409	51248342
		2-1/4" (57)	N/A	51356723
		2-1/2" (64)	N/A	51293017

Product	Description	Bit Diameter in	Depth in	Length in	Part Number		
					7/8" x 3-1/4"	7/8" x 4-1/4"	1" x 4-1/4"
	Carbide-tipped Drill Steel	5/8"	15"	18"	WB581518	WBA581518	N/A
		5/8"	21"	24"	WB582124	WBA582124	N/A
		3/4"	15"	18"	WB341518	WBA341518	WBC341518
		3/4"	21"	24"	WB342124	WBA342124	WBC342124
		7/8"	15"	18"	WB781518	WBA781518	WBC781518
		7/8"	21"	24"	WB782124	WBA782124	WBC782124
		1"	15"	18"	WB11518	WBA11518	WBC11518
		1"	21"	24"	WB12124	WBA12124	WBC12124
		1-1/8"	15"	18"	WB1181518	WBA1181518	WBC1181518
		1-1/8"	21"	24"	WB1182124	WBA1182124	WBC1182124

A full line of carbide-tipped drill steels and 1-1/4" x 4-1/4" hex shank rope thread jackrod is available from the Ingersoll Rand Construction Tool Steels and Accessories catalog, along with other sizes of jackrod and bits: Form # IRPS-0407-006.

## Rivet Busters

- ▶ Piston bridge prevents accidental discharge for increased safety
- ▶ Steel throttle valve
- ▶ Case-hardened alloy steel cylinder
- ▶ Heavy-duty upper and lower sleeves
- ▶ Takes industry standard jumbo steel
- ▶ Directional exhaust (9001 and 11001 models only)



Model	Barrel Type	Stroke in (mm)	Bore in (mm)	Length Without Accessory in (mm)	Weight Without Accessory lb (kg)	bpm	cfm	Inlet Size NPT in	Recommended Hose Size in (mm)
8001A	Grooved barrel with lock spring	8" (203)	1.19" (30)	22.5" (572)	30 (13.6)	1,140	44	1/2"	3/4" (19)
9001A	Grooved barrel with lock spring	9" (229)	1.06" (27)	22.5" (572)	24.75 (11.2)	900	40	1/2"	3/4" (19)
9001	Threaded barrel with lock clip	9" (229)	1.06" (27)	22.5" (572)	24.75 (11.2)	900	40	1/2"	3/4" (19)
11001A	Grooved barrel with lock spring	11" (279)	1.06" (27)	24.5" (622)	30.21 (13.7)	800	45	1/2"	3/4" (19)
11001	Threaded barrel with lock clip	11" (279)	1.06" (27)	24.5" (622)	30.21 (13.7)	800	45	1/2"	3/4" (19)

Performance figures are at 90 psi (6.2 bar) air pressure.

## Rivet Buster Steels and Retainers

Product	Description	Length in (mm)	Part Number
	Moil Point	9" (229)	9001-297-9
		12" (305)	9001-297-12
	Chisels	9-1/2" (241)	9001-276-9-1/2
		12" (305)	9001-276-12
		18" (457)	9001-276-18
	Side-cut Chisel	9-1/2" (241)	9001-277-9-1/2
		12" (305)	9001-277-12
	Ripper Chisel	9-1/2" (241)	9001-295-9-1/2
		12" (305)	9001-295-12

Product	Description	Threaded Barrel 9001, 11001	Grooved Barrel 8001A, 9001A, 11001A
	Retainer	N/A	89938443
	Retainer	9001-200	N/A
	Upper Sleeve	9001-220	9001-220
	Lower Sleeve	9001-201	9001-201

Product	Description	Threaded Barrel 9001, 11001	Grooved Barrel 8001A, 9001A, 11001A
	Bumper	9001-203	9001-203
	Lock Clip	9RB-207	N/A
	Spring Lock	N/A	89938450
	Key	9001-208	N/A
	Pin	FMD2-667	N/A

## Chipping Hammers

### K Series

- ▶ General / light-duty
- ▶ Grooved barrel with lock-spring retainer
- ▶ Swan-neck handle with outside trigger
- ▶ Replaceable piston
- ▶ Uses oval collar accessories



K2LA1

### D Series

- ▶ Construction-duty
- ▶ Die-cast aluminum handle with outside trigger
- ▶ Directional exhaust
- ▶ Available in 2", 3", or 4" stroke
- ▶ Tease throttle
- ▶ Uses oval collar accessories



2DA2SA

Model	Retainer Type	Stroke in (mm)	Bore in (mm)	Length Without Accessory in (mm)	Weight Without Accessory lb (kg)	bpm	cfm	Inlet Size NPT in	Recommended Hose Size in (mm)
<b>K SERIES LIGHT-DUTY CHIPPERS</b>									
<b>WITH .580" HEX NOZZLE — FOR USE WITH HEX SHANK OVAL COLLAR ACCESSORIES</b>									
K2LA1	None	1.75" (44)	0.88" (22)	10.88" (276)	6 (2.72)	3,600	18	1/4"	1/2" (13)
K2LA1SA	Standard	1.75" (44)	0.88" (22)	12" (305)	8 (3.63)	3,600	18	1/4"	1/2" (13)
<b>WITH .680" ROUND NOZZLE — FOR USE WITH ROUND SHANK OVAL COLLAR ACCESSORIES</b>									
K2LA2	None	1.75" (44)	0.88" (22)	10.88" (276)	6 (2.72)	3,600	18	1/4"	1/2" (13)
K2LA2SA	Standard	1.75" (44)	0.88" (22)	12" (305)	8 (3.63)	3,600	18	1/4"	1/2" (13)
<b>D SERIES CONSTRUCTION-DUTY CHIPPERS</b>									
<b>WITH .580" HEX NOZZLE — FOR USE WITH HEX SHANK OVAL COLLAR ACCESSORIES</b>									
2DA1SA	Standard	2" (51)	1.13" (29)	13.75" (349)	13.75 (6.25)	2,200	28	7/8"-24	1" (25)
3DA1SA	Standard	3" (76)	1.13" (29)	17" (432)	15 (6.82)	1,900	31	7/8"-24	1" (25)
4DA1SA	Standard	4" (102)	1.13" (29)	18" (457)	16 (7.27)	1,600	34	7/8"-24	1" (25)
<b>WITH .680" ROUND NOZZLE — FOR USE WITH ROUND SHANK OVAL COLLAR ACCESSORIES</b>									
2DA2SA	Standard	2" (51)	1.13" (29)	13.75" (349)	13.75 (6.25)	2,200	28	7/8"-24	1" (25)
3DA2SA	Standard	3" (76)	1.13" (29)	17" (432)	15 (6.82)	1,900	31	7/8"-24	1" (25)
4DA2SA	Standard	4" (102)	1.13" (29)	18" (457)	16 (7.27)	1,600	34	7/8"-24	1" (25)

Performance figures are at 90 psi (6.2 bar) air pressure.

## Chipping Hammers

### A Series

- ▶ Industrial-duty
- ▶ Grooved barrel with lock-spring retainer
- ▶ Swan-neck handle with outside trigger
- ▶ Replaceable piston
- ▶ Uses oval collar accessories

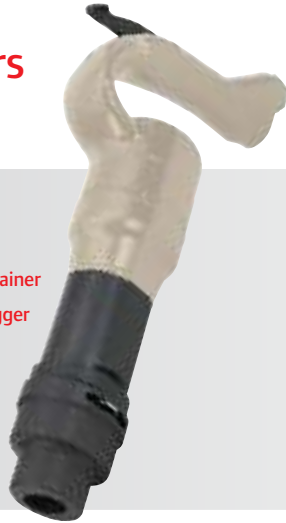

2A2SA

### W Series

- ▶ Heavy-duty
- ▶ Swan-neck handle with outside trigger
- ▶ Heavy-duty threaded barrel
- ▶ Rubber buffered screw on retainer
- ▶ Uses round collar accessories







W3A2







Model	Retainer Type	Stroke in (mm)	Bore in (mm)	Length Without Accessory in (mm)	Weight Without Accessory lb (kg)	bpm	cfm	Inlet Size NPT in	Recommended Hose Size in (mm)
<b>A SERIES INDUSTRIAL-DUTY CHIPPERS</b>									
<b>WITH .580" HEX NOZZLE — FOR USE WITH (X4) HEX SHANK OVAL COLLAR ACCESSORIES</b>									
1A1SA	Standard	1" (25)	1.13" (28)	15.5" (394)	14.75 (6.69)	2,500	28	3/8"	1/2" (13)
2A1SA	Standard	2" (51)	1.13" (28)	16" (406)	15.13 (6.86)	2,300	28	3/8"	1/2" (13)
3A1SA	Standard	3" (76)	1.13" (28)	17.88" (454)	16.63 (7.54)	1,725	29	3/8"	1/2" (13)
4A1SA	Standard	4" (102)	1.13" (28)	18.88" (480)	17.5 (7.94)	1,480	29	3/8"	1/2" (13)
<b>WITH .680" ROUND NOZZLE — FOR USE WITH (X4) ROUND SHANK OVAL COLLAR ACCESSORIES</b>									
1A2SA	Standard	1" (25)	1.13" (28)	15.5" (394)	14.75 (6.69)	2,500	28	3/8"	1/2" (13)
2A2SA	Standard	2" (51)	1.13" (28)	16" (406)	15.13 (6.86)	2,300	28	3/8"	1/2" (13)
3A2SA	Standard	3" (76)	1.13" (28)	17.88" (454)	16.63 (7.54)	1,725	29	3/8"	1/2" (13)
4A2SA	Standard	4" (102)	1.13" (28)	18.88" (480)	17.5 (7.94)	1,480	29	3/8"	1/2" (13)
<b>W SERIES HEAVY-DUTY CHIPPERS</b>									
<b>WITH .580" HEX NOZZLE — FOR USE WITH (X4) HEX SHANK ROUND COLLAR ACCESSORIES</b>									
W1A1	Rubber-buffered	1" (25)	1.13" (28)	15.88" (403)	14.75 (6.69)	2,500	28	3/8"	1/2" (13)
W2A1	Rubber-buffered	2" (51)	1.13" (28)	16.38" (416)	15.13 (6.86)	2,300	28	3/8"	1/2" (13)
W3A1	Rubber-buffered	3" (76)	1.13" (28)	18.25" (464)	16.63 (7.54)	1,725	29	3/8"	1/2" (13)
W4A1	Rubber-buffered	4" (102)	1.13" (28)	19.25" (489)	17.5 (7.94)	1,480	29	3/8"	1/2" (13)
<b>WITH .680" ROUND NOZZLE — FOR USE WITH (X4) ROUND SHANK ROUND COLLAR ACCESSORIES</b>									
W1A2	Rubber-buffered	1" (25)	1.13" (28)	15.88" (403)	14.75 (6.69)	2,500	28	3/8"	1/2" (13)
W2A2	Rubber-buffered	2" (51)	1.13" (28)	16.38" (416)	15.13 (6.86)	2,300	28	3/8"	1/2" (13)
W3A2	Rubber-buffered	3" (76)	1.13" (28)	18.25" (464)	16.63 (7.54)	1,725	29	3/8"	1/2" (13)
W4A2	Rubber-buffered	4" (102)	1.13" (28)	19.25" (489)	17.5 (7.94)	1,480	29	3/8"	1/2" (13)

Performance figures are at 90 psi (6.2 bar) air pressure.





## Chipping Hammer Steels and Retainers

Product	Description	Under Collar Length	K, A, and D Series		W Series	
			0.68 Round Shank Oval Collar	0.58 Hex Shank Oval Collar	0.68 Round Shank Round Collar	0.58 Hex Shank Round Collar
	1" Flat Chisel	9"	HH1-215F-9	HH1-214F-9	H3R-215F-9	H3R-214F-9
		12"	HH1-215F-12	HH1-214F-12	H3R-215F-12	H3R-214F-12
		18"	HH1-215F-18	HH1-214F-18	H3R-215F-18	H3R-214F-18
	Moil Point	9"	HH1-215M-9	HH1-214M-9	H3R-215M-9	H3R-214M-9
		12"	HH1-215M-12	HH1-214M-12	H3R-215M-12	H3R-214M-12
		18"	HH1-215M-18	HH1-214M-18	H3R-215M-18	H3R-214M-18
	2" Scaling Chisel	9"	HH1-323-9	HH1-324-9	HH1-423-9	HH1-424-9
		12"	HH1-323-12	HH1-324-12	H3R-423-12	H3R-424-12
	Diamond Point	12"	HH1-215D-12	HH1-214D-12	H3R-215D-12	H3R-214D-12
	Bushing Tool	9"	HH1-215T-9	HH1-214T-9	H3R-215T-9	H3R-214T-9

Other steels available from Ingersoll Rand Construction Tool Steels and Accessories Catalog, Form # IRPS-0407-006 including spark-resistant chisels, blanks, capes, gouges, round noses, fullers, caulking, ripper chisels, tooth chisels, and paper box stripping chisels.

Product	Description	Barrel Type	K, A, and D Series	W Series
	Standard Standard on all chippers ending in SA	Grooved	HH1-1190	N/A
	Optional Quick Change	Grooved	HH1-1191	N/A
	Optional Quick Change	Grooved	HH1-3400-3	N/A
	Lock Spring Used on all grooved barrel retainers	Grooved	HH1-1194	N/A
	Rubber-Buffered* Standard on all W Series chippers	Threaded	N/A	HHW1-A300
	Optional Economy Type	Threaded	N/A	HHW2-200
	Optional Quick Change	Threaded	N/A	HHW1-3450

\*W Series chipper with rubber-buffered retainer, part number HHW1-A300, includes the parts below.

Product	Description	Part Number
	Upper Buffer Washer (2 pieces)	H3R-31
	Lower Buffer Washer (2 pieces)	HHW1-213
	Lower Buffer Washer Ring	R000A2-103
	Rubber Bumper	H3R-203
	Lock Clip	24SR-207

## Backfill Tampers and Sand Rammers



### Sand Rammers

- ▶ Time-tested valve design
- ▶ Round piston rod
- ▶ Dual-action sand wiper keeps dirt out of the barrel
- ▶ 2-1/2" butt standard on 130A1M; 3" butt standard on 241A1M

### Backfill Tampers

- ▶ Built-in lubricator and muffler
- ▶ Dual-action sand wiper keeps dirt out of the barrel
- ▶ Plated piston
- ▶ 5-3/4" round malleable butt standard on both the 341A2M and 441A2

130A1M

241A1M

341A2M

441A2

Model	Type	Stroke in (mm)	Bore in (mm)	Length in (mm)	Weight lb (kg)	bpm	cfm	Inlet Size NPT in	Recommended Hose Size in (mm)
<b>SAND RAMMERS</b>									
130A1M	Bench	2.5" (63)	1" (25)	21.5" (546)	11.56 (5.24)	870	14	1/4"	3/8" (10)
241A1M	Floor	4" (102)	1.31" (33)	52.75" (1340)	26.88 (12.2)	1,590	29	3/8"	1/2" (13)
<b>BACKFILL TAMPERS</b>									
341A2M	N/A	4" (102)	1.63" (41)	52.75" (1340)	34.88 (15.8)	1,550	29	3/8"	1/2" (13)
441A2	N/A	4" (102)	2" (51)	50.88" (1292)	47.13 (21.4)	1,750	36	3/8"	1/2" (13)

Performance figures are at 90 psi (6.2 bar) air pressure.

### Accessory Options

Description Of Butt	Part Number
<b>FOR MODEL 130A1M — 1/2" TAPERED ROD</b>	
Malleable butt 2-1/2" (64 mm) diameter, standard	12SR-83
Rubber-tipped butt 2-3/8" (60 mm) diameter	14SR-83R-2-3/8
Rubber topping-off butt 3-29/32" (99 mm) diameter	14SR-83R-4
Rubber-tipped peen	14SR-93R
<b>FOR MODEL 341A2M — 7/8" TAPERED ROD</b>	
Malleable butt 5-3/4" (146 mm) diameter, standard	34SR-M183-5-3/4
Steel butt 3" (76 mm) diameter	34SR-383

Description Of Butt	Part Number
<b>FOR MODEL 241A1M — 5/8" TAPERED ROD</b>	
Malleable butt 3" (76 mm) diameter, standard	22SR-83-3x3/4
Rubber-tipped butt 3" (76 mm) diameter	24SR-83R-3
Rubber-tipped butt 5" (127 mm) diameter	24SR-83R-5
<b>FOR MODEL 441A2 — 1" TAPERED ROD</b>	
Malleable butt 5-3/4" (146 mm) diameter, standard	44SR-M183-5-3/4
Half-moon butt 5-1/4" (133 mm) diameter	44SR-HM183-5

## Air Line Accessories



### Hoses

Part Number	Hose ID in	Length ft	Rated psi
<b>DOUBLE-BANDED UNIVERSAL — BOTH ENDS</b>			
22040679	3/4"	50'	300
<b>DOUBLE-BANDED UNIVERSAL — 3/8" NPT STRAIGHT MALE</b>			
22040687	1/2"	8'	250
<b>DOUBLE-BANDED UNIVERSAL — 1/2" NPT STRAIGHT MALE</b>			
22041453	1/2"	8'	250
<b>DOUBLE-BANDED UNIVERSAL — 1/2" NPT SWIVEL MALE</b>			
22041479	1/2"	8'	250

### Needle Pressure Gauge

Part Number	Description
NPG-A1	Gauge kit

### Swivel Inlets

Part Number	Description	Duty Type
HH1-A165	3/8" NPT x 1/2" hose barb	General-duty
HH1-SW7/8	7/8" x 24" NPT x 1/2" hose barb	General-duty
HH1-VSW7/8	7/8" x 24" NPT x 1/2" hose barb	Heavy-duty
HH1-VSW1/2	1/2" NPT x 1/2" hose barb	Heavy-duty







### Oilers

Oil Capacity	3 oz	5 oz	8 oz	16 oz
NPT Pipe Size	1/2"	3/4"	3/4"	1"
Part Number	3LUB8	6LUB12	8LUB12	16LUB16

### Combination Unit with Gauge

Female NPT	FRL Part Number
1/4" Mini	C28121-800
1/4"	C28221-810
3/8"	C28231-810
1/2"	C28241-810
3/4"	C31-06-G00
1"	C31-08-G00

### Couplers

Hose / Pipe Thread in	Universal To Female	Universal To Hose Barb	Universal To Male	OSHA Shut-off Valve	Universal 3-way	Universal Coupler Gasket	Hose Clamp
3/8"	N/A	N/A	UM-37-M	N/A	UW-300-B	UG-100	MT1-AL34-3/8
1/2"	UF-50-M	UH-50-M	UM-50-M	N/A	UW-300-B	UG-100	MT1-AL34-1/2
3/4"	UF-75-M	UH-75-M	UM-75-M	170-6	UW-300-B	UG-100	MT1-AL34-3/4
1"	UF-100-M	UH-100-M	UM-100-M	170-8	UW-300-B	UG-100	MT1-AL34-1
							



# Air Compressors



---

Portable Air Compressors **17**

---

Single-stage Air Compressors **17**

---

Two-stage Air Compressors **19**

---

## Single-stage Air Compressors

### Twin-stack compressors

The Ingersoll Rand twin-stack, hand-carry air compressor is designed to provide power, durability, and portability on the jobsite. Built to last, this oil-lube compressor with durable cast-iron cylinders is designed for 100% continuous-duty applications. The twin-stack includes a 1/4" universal coupler, conveniently mounted regulator and pressure gauge, 4.5-gal twin tanks, All-Season Select® lubricant, and a power cord.

- ▶ Lightweight and compact hand-carry size
- ▶ Durable cast-iron construction
- ▶ Extended pump life — lubricated pump offers double the life of similar oil-free products

DD2T2



### Electric-driven, single-stage compressors

Our single-stage electric air compressors are ideal for anyone from the do-it-yourselfer to the professional user. Each compressor features durable cast-iron construction, 100% continuous-duty cycle for the toughest applications, and extended pump life for years of trouble-free service.

- ▶ Industrial-quality design
- ▶ Durable cast-iron construction
- ▶ 135 psi maximum operating pressure

SS5L5



SS3L3



### Garage Mate compressors

Designed for professionals and serious do-it-yourselfers, the versatile Garage Mate is ideal for the home, shop, or jobsite and can deliver maximum air to a variety of tools. It features a cast-iron, oil-lubricated pump for solid, reliable performance. Belt-driven for quiet operation, all models are equipped with a pressure switch, pressure gauge, regulator, safety valve, manual drain, and 6' power cord.

- ▶ 100% continuous-duty for tough applications
- ▶ Durable cast-iron construction
- ▶ Quiet operation of 75 to 80 dBA

SS3F2-GM



SS3R2-GM



### Single-stage Units

Model	Running hp	Voltage	Tank	cfm @ 90 psi	Max psi	NPT Outlet in	Package Dimensions l x w x h in	Net Weight lb
DD2T2	2	115-1-60	4.5-gal twin	4.4	135	3/8"	21" x 15" x 17"	58
SS3R2-GM	2	115-1-60	24-gal vert	5.7	135	3/8"	23" x 25" x 51"	185
SS3F2-GM	2	115-1-60	30-gal horiz	5.7	135	3/8"	46" x 25" x 35"	185
SS3L3	3	230-1-60	60-gal vert	11.3	135	3/8"	20" x 23" x 66"	300
SS5L5	5	230-1-60	60-gal vert	18.1	135	1/2"	20" x 30" x 71"	310

## Wheelbarrow compressors

Ingersoll Rand electric- and gas-engine wheelbarrow air compressors are lightweight with a low-profile design to provide maximum maneuverability. Built to last, these cast-iron, oil-lube compressors are designed for 100% continuous-duty applications. Each unit includes pressure switch, regulator and gauge, two quick disconnects to power multiple tools, and twin 8-gal capacity tanks. The electric model features a belt drive for quiet operation (76 dBA), a 6' power cord and dual voltage (2-hp model only). Where electric power is not readily available, the gas-driven model is powered by either a Honda or Briggs & Stratton 5.5-hp high-performance engine.

- ▶ Designed for maximum maneuverability on the jobsite
- ▶ Durable cast-iron construction
- ▶ 100% continuous-duty for tough applications
- ▶ Includes two quick disconnects to power multiple tools

SS3J5.5GH-WB<sup>1</sup>

## Air Sled compressors

Electric- and gas-engine Air Sled compressors feature a rugged frame support to meet the rigorous demands of field handling. Base package includes pressure gauge, manual drain, two quick disconnects to power multiple tools, and twin 8-gal capacity tanks. Electric model is belt-driven to provide quiet operation (76 dBA) and includes a 6' power cord. The gas-driven model is powered by a premium Honda engine. Available options include regulation panel, cart assembly, hose rack, and weatherproof cover.

- ▶ Ergonomically designed with rugged frame support to meet the rigorous demands of field handling
- ▶ Durable cast-iron construction; oil lube
- ▶ Two quick disconnects to power multiple tools

SS3J5.5GH-AS<sup>2</sup>

### Single-stage Units

Model	Running hp	Voltage	Tank	cfm @ 90 psi	Max psi	NPT Outlet in	Package Dimensions l x w x h in	Net Weight lb
<b>ELECTRIC</b>								
SS3J2-WB	2	115/230-1-60	8-gal twin	5.7	135	3/8"	43" x 18" x 25"	175
SS3J3-WB	3	230-1-60	8-gal twin	11.3	135	3/8"	43" x 18" x 25"	175
SS3J3-AS	3	230-1-60	8-gal twin	11.3	135	3/8"	38" x 18" x 26"	174

Model	Running hp	Engine	Tank	cfm @ 90 psi	Max psi	NPT Outlet in	Package Dimensions l x w x h in	Net Weight lb
<b>GAS</b>								
SS3J5.5GB-WB	5.5	Briggs & Stratton	8-gal twin	11.8	135	3/8"	43" x 18" x 25"	175
SS3J5.5GH-WB	5.5	Honda	8-gal twin	11.8	135	3/8"	43" x 18" x 25"	175
SS3J5.5GH-AS	5.5	Honda	8-gal twin	11.8	135	3/8"	38" x 19" x 27"	177

<sup>1</sup> WB = Wheelbarrow    <sup>2</sup> AS = Air Sled

## Two-stage Air Compressors

### Electric-driven two-stage compressors

Ingersoll Rand high-performance two-stage compressors are fully packaged and designed for the most demanding automotive, heavy-duty commercial, or industrial applications where dependable air supply is essential. Each fully packaged air compressor comes with a pre-installed magnetic motor starter, air-cooled aftercooler, and an electric drain valve to remove harmful moisture, plus the added protection of a low-oil level shutdown switch.



2340L5

- ▶ Durable cast-iron, two-stage design offers extended pump life for years of trouble-free service
- ▶ 175 psi maximum operating pressure
- ▶ 100% continuous-duty for tough applications
- ▶ Includes magnetic motor starter, air-cooled aftercooler, electronic drain valve, low-oil level shutdown switch, and ASME tank

### Truck-mount compressors

- ▶ Truck-bed mounting
- ▶ Electronic ignition
- ▶ Idle engine control
- ▶ 30-gal ASME receiver
- ▶ OSHA-approved, fully enclosed belt guard
- ▶ Weather-resistant powdercoat paint finish
- ▶ Durable cast-iron construction
- ▶ 175 psi maximum operating pressure
- ▶ Extended pump life
- ▶ 100% duty cycle for tough applications



2475F13GH



2475F12.5G

### Two-stage Units

Model	Running hp	Engine	Tank	cfm @ 175 psi	Max psi	NPT Outlet in	Package Dimensions l x w x h in	Net Weight lb
2475F13GH/AH	13	Honda with alternator	30-gal horiz	25	175	3/4"	44" x 22" x 41"	430
2475F12.5G	12.5	Kohler	30-gal horiz	24	175	3/4"	44" x 22" x 48"	429
2475F12.5G/AH	12.5	Kohler with alternator	30-gal horiz	24	175	3/4"	44" x 22" x 48"	429
2340L5	5	—	60-gal vert	15.6	175	1/2"	20" x 33" x 69"	400

# Service and Maintenance Tools



Impactools™ and Ratchets	21
IQ™ Series Cordless Tools	23
Socket Sets	26
Saws	27
Large Drills	28
Grinders and Surface Preparation Tools	30
Needle and Chisel Scalers	32
De-watering Pumps	34

## 3/8" and 1/2" Impactools™ and Ratchets



Model*	Description	Handle	Free Speed rpm	Max Torque ft-lb (Nm)	Recommended Torque Range ft-lb (Nm)	Weight lb (kg)	Length in (mm)	cfm	Recommended Hose Size in (mm)
<b>3/8" RATCHETS</b>									
107XPA	3/8" square	Lever	160	54 (73)	10 – 45 (14 – 61)	2.75 (1.25)	11" (279)	19	3/8" (10)
109XPA	3/8" square	Lever	220	76 (95)	10 – 60 (14 – 81)	3.3 (1.4)	12" (302)	24	3/8" (10)
<b>IMPACTOOLS</b>									
<b>3/8" HEAVY-DUTY</b>									
1702P1	3/8" square	Pistol	10,000	125 (170)	20 – 100 (27 – 136)	2.75 (1.25)	5.5" (140)	15	5/16" (8)
<b>3/8" MAINTENANCE-DUTY</b>									
2115PTiMAX	3/8" square reverse bias	Pistol	15,000	F: 250 (339) R: 300 (407)	25 – 230 (34 – 312)	2.49 (1.13)	5.95" (151)	17	3/8" (10)
2115TiMAX	3/8" square reverse bias	Pistol	15,000	F: 250 (339) R: 300 (407)	25 – 230 (34 – 312)	2.48 (1.12)	5.95" (151)	17	3/8" (10)
212	3/8" square	Pistol	10,000	180 (244)	20 – 150 (27 – 204)	2.89 (1.31)	6" (152)	11	3/8" (10)
<b>1/2" MAINTENANCE-DUTY</b>									
2135PTiMAX	1/2" square reverse bias	Pistol	9,800	F: 600 (813) R: 780 (1054)	50 – 550 (68 – 746)	3.95 (1.79)	7.35" (187)	24	3/8" (10)
2135TiMAX	1/2" square reverse bias	Pistol	9,800	F: 600 (813) R: 780 (1054)	50 – 550 (68 – 746)	3.95 (1.79)	7.35" (187)	24	3/8" (10)
2135Ti-2MAX	1/2" square 2" extended anvil	Pistol	9,800	F: 600 (813) R: 780 (1054)	50 – 550 (68 – 746)	4.4 (2)	9.47" (241)	24	3/8" (10)
2135QTiMAX	1/2" square Quiet tool	Pistol	9,800	F: 600 (813) R: 780 (1054)	50 – 550 (68 – 746)	4.05 (1.84)	7.35" (187)	24	3/8" (10)
2135QPTiMAX	1/2" square Quiet tool	Pistol	9,800	F: 600 (813) R: 780 (1054)	50 – 550 (68 – 746)	4.05 (1.84)	7.35" (187)	24	3/8" (10)
231HA-2	1/2" square 2" extended anvil	Pistol	8,000	590 (800)	25 – 350 (34 – 475)	6.1 (2.76)	9.13" (236)	22	3/8" (10)
231C	1/2" square	Pistol	8,000	600 (813)	25 – 350 (34 – 475)	5.8 (2.63)	7.3" (185)	22	3/8" (10)
232TGSL	1/2" square	Pistol	10,000	625 (847)	40 – 400 (54 – 544)	6 (2.72)	7.3" (185)	23	3/8" (10)

\*P denotes a pin-type socket retainer in drive sizes 3/8" – 1/2" and a through-hole socket retainer in drive sizes 3/4" and above.

## 3/4" – 1-1/2" Industrial Impacttools



2925P1

- ▶ 3/4" square drive
- ▶ Textured epoxy finish
- ▶ Corrode-X protects components from corrosion
- ▶ Twin-hammer mechanism
- ▶ 3-position power regulation
- ▶ 360° swivel air inlet



3940B2Ti

- ▶ 1" square drive
- ▶ High-efficiency, 7-vane, reverse-bias motor
- ▶ Pressure-fed lubrication system
- ▶ Twin-hammer mechanism
- ▶ Integral muffler
- ▶ Bronze endplates



2190Ti-6

- ▶ Revolutionary tire-change handle designed specifically for high-volume fleet service
- ▶ Now features improved anvil, bushing, and exhaust designs
- ▶ 6" extended anvil
- ▶ Ergonomically designed handle and grip

Model*	Description	Handle	Free Speed rpm	Max Torque ft-lb (Nm)	Recommended Torque Range ft-lb (Nm)	Weight lb (kg)	Length in (mm)	cfm	Recommended Hose Size in (mm)
<b>3/4" SUPER-DUTY</b>									
2925P1	3/4" square	Pistol	5,200	1,450 (1,966)	350 – 1,100 (476 – 1,496)	12.5 (5.7)	8.88" (225)	60	1/2" (13)
2925RBP1	3/4" square reverse bias	Pistol	5,200	F: 1,300 (1,763) R: 1,600 (2,169)	400 – 1,400 (542 – 1,898)	12.5 (5.7)	8.88" (225)	60	1/2" (13)
<b>3/4" HEAVY-DUTY</b>									
1720P1	3/4" square	Pistol	5,500	1,000 (1,360)	200 – 600 (271 – 814)	11.88 (5.39)	7.63" (194)	40	1/2" (13)
<b>3/4" MAINTENANCE-DUTY</b>									
2141P	3/4" square reverse bias	Pistol	7,250	F: 1,000 (1,356) R: 1,200 (1,627)	200 – 900 (271 – 1,220)	7 (3.2)	8.2" (208)	40	1/2" (13)
<b>1" SUPER-DUTY</b>									
2925P3	1" square	Pistol	5,200	1,450 (1,966)	350 – 1,100 (475 – 1,492)	11.88 (5.39)	8.88" (225)	60	1/2" (13)
2925RBP3	1" square reverse bias	Pistol	5,200	F: 1,300 (1,763) R: 1,600 (2,169)	400 – 1,400 (407 – 1,763)	11.88 (5.39)	8.88" (225)	60	1/2" (13)
3940B2Ti	1" square reverse bias	Grip I.T.	6,000	F: 2,500 (3,390) R: 2,750 (3,730)	500 – 1,650 (680 – 2,240)	21.2 (9.6)	13.5" (343)	75	3/4" (19)
3940P2Ti	1" square reverse bias	Pistol	5,300	F: 2,500 (3,390) R: 2,750 (3,730)	500 – 1,650 (680 – 2,440)	20.4 (9.3)	10.1" (256)	75	3/4" (19)
3942B2Ti	1" square reverse bias	Grip I.T.	5,000	F: 2,750 (3,390) R: 3,250 (4,406)	1,000 – 1,950 (1,356 – 2,644)	22.6 (10.5)	14.3" (362)	95	3/4" (19)
<b>1" HEAVY-DUTY</b>									
1712B2	1" square	Grip I.T.	6,000	1,400 (1,898)	450 – 1,000 (612 – 1,860)	18.25 (8.28)	11.25" (286)	47	3/4" (19)
1712P2	1" square	Pistol	6,000	1,350 (1,830)	450 – 1,000 (612 – 1,860)	18.25 (8.28)	11.25" (286)	56	3/4" (19)
<b>1" MAINTENANCE-DUTY</b>									
2190Ti-6	1" square 6" extended anvil	Grip I.T.	6,800	1,650 (2,237)	150 – 1,200 (204 – 1,627)	15.5 (7.03)	21.48" (546)	58	1/2" (13)
285B-6	1" square 6" extended anvil	Grip I.T.	5,000	1,475 (2,000)	100 – 900 (136 – 1,220)	27.8 (12.61)	20.1" (511)	45	1/2" (13)
280-S-6	#5 splined 6" extended anvil	Grip I.T.	6,000	1,600 (2,169)	150 – 1,000 (204 – 1,360)	23.8 (10.80)	18.5" (470)	55	1/2" (13)
<b>1-1/2" SUPER-DUTY</b>									
3955B2Ti	1-1/2" square reverse bias	Grip I.T.	2,750	F: 4,700 (6,372) R: 5,000 (6,779)	1,600 – 3,900 (2,169 – 5,288)	34.6 (15.7)	16.5" (419.1)	80	3/4" (19)

\*P denotes a pin-type socket retainer in drive sizes 3/8" – 1/2" and a through-hole socket retainer in drive sizes 3/4" and above.  
IT = Inside trigger OT = Outside trigger

## IQ™ Series Cordless Tools

### D550 Cordless Drill / Driver

- ▶ 550 in-lb ideal stall torque
- ▶ Lightweight — only 4.3 lb with 14.4 volt lithium-ion battery
- ▶ All-metal industrial ratchet lock chuck



### D650 Cordless Drill / Driver

- ▶ 650 in-lb ideal stall torque
- ▶ Lightweight — only 4.5 lb with 19.2-volt lithium-ion battery
- ▶ All-metal industrial ratchet lock chuck



Model	Ideal Stall Torque in-lb (Nm)	Speed rpm	Weight* lb (kg)	NiCd Weight** lb (kg)	Li-Ion Weight** lb (kg)	Length in (cm)	Sound dBA	Voltage volts
D550	550 (62)	0 – 360 / 1,300	3 (1.4)	4.8 (2.1)	4.3 (1.9)	9.2" (233)	67 / 78	14.4
D650	650 (73)	0 – 360 / 1,300	3 (1.4)	7.2 (3.3)	4.5 (2)	9.2" (233)	67 / 78	19.2

Batteries and chargers sold separately.

\*Tool only, does not include battery.

\*\*Weight of tool with battery.

### R140 Cordless 1/4" Mini Ratchet

- ▶ Impressive mobility for hard-to-reach tasks
- ▶ 25 ft-lb of maximum torque
- ▶ Compatible with 7.2-volt IQ<sup>v</sup> lithium-ion and nickel-cadmium batteries



### R380 Cordless 3/8" Standard Ratchet

- ▶ Proprietary motor control with variable speed
- ▶ Advanced head design — built with the proven 107XPA pneumatic ratchet head
- ▶ Compatible with all 14.4-volt IQ<sup>v</sup> batteries including lithium-ion and nickel-cadmium



Model	Type	Anvil Size in	Voltage volts	Useable Torque Range ft-lb (Nm)	Max Torque ft-lb (Nm)	Free Speed rpm	Weight* lb (kg)	NiCd Weight** lb (kg)	Li-Ion Weight** lb (kg)	Length in (mm)	Switch Type	Sound dBA
R140	Mini	1/4"	7.2	5 – 25 (7 – 34)	25 (34)	225	2 (0.9)	3.1 (1.4)	2.9 (1.3)	10.7" (272)	Variable speed	74.9
R145	Mini	3/8"	7.2	5 – 25 (7 – 34)	25 (34)	225	2 (0.9)	3.1 (1.4)	2.9 (1.3)	10.7" (272)	Variable speed	74.9
R380	Standard	3/8"	14.4	10 – 60 (14 – 81)	70 (94)	225	2.8 (1.3)	4.6 (2)	4.1 (1.9)	12.4" (315)	Variable speed	80.8
R385	Standard	1/2"	14.4	10 – 60 (14 – 81)	70 (94)	225	2.8 (1.3)	4.6 (2)	4.1 (1.9)	12.4" (315)	Variable speed	80.8

Batteries and chargers sold separately.

\*Tool only, does not include battery.

\*\*Weight of tool with battery.



**TL10**  
High Intensity LED Task Light

- ▶ Works with all IQ<sub>v</sub> batteries
- ▶ 160° pivoting, low-profile head provides lighting versatility
- ▶ High-quality 4-watt LED bulb lasts for up to 50,000 hours
- ▶ Drop-resistant housing design features chemical-resistant composite materials



Model	BL 72 Battery Runtime hr	BL 144 Battery Runtime hr	BL 192 Battery Runtime hr	Weight* lb (kg)	Height in (mm)	Volts
TL10	4	8	10	0.8 (0.36)	8.3" (211)	7.2, 14.4, or 19.2

\*Tool only, does not include battery.



**W040**  
1/4" Cordless Impactool

- ▶ Lightweight and compact for easy access in confined spaces
- ▶ 40 ft-lb maximum reverse torque
- ▶ Lightweight — only 2.7 lb with lithium-ion battery

**W150**  
3/8" Cordless Impactool

- ▶ The most powerful and durable cordless Impactool in its class
- ▶ 150 ft-lb maximum reverse torque
- ▶ Lightweight — only 4.5 lb with lithium-ion battery

**W360**  
1/2" Cordless Impactool

- ▶ Pound-for-pound, the most powerful cordless Impactool in the world
- ▶ 360 ft-lb maximum reverse torque
- ▶ Lightweight — only 6.2 lb with lithium-ion battery

Model	Description	Max Torque ft-lb (Nm)	Usable Torque Range ft-lb (Nm)	Speed rpm	bpm	Weight* lb (kg)	NiCd Weight** lb (kg)	Li-Ion Weight** lb (kg)	Length in (cm)	Sound Pressure / Power dBA	Voltage volts
W040	1/4" quick change	40 (54)	1 - 32 (2 - 43)	0 - 2,200	0 - 2,500	1.8 (0.8)	2.9 (1.3)	2.7 (1.2)	7" (17.8)	90 / 101	7.2
W040SQ	3/8" square	40 (54)	1 - 32 (2 - 43)	0 - 2,200	0 - 2,500	1.8 (0.8)	2.9 (1.3)	2.7 (1.2)	7" (17.8)	90 / 101	7.2
W040P	3/8" square pin	40 (54)	1 - 32 (2 - 43)	0 - 2,200	0 - 2,500	1.8 (0.8)	2.9 (1.3)	2.7 (1.2)	7" (17.8)	90 / 101	7.2
W150	3/8" square	150 (203)	25 - 130 (34 - 176)	0 - 2,200	0 - 3,000	3.2 (1.5)	5 (2.3)	4.7 (2.1)	8.2" (20.9)	90 / 101	14.4
W150QC	1/4" quick change	150 (203)	25 - 130 (34 - 176)	0 - 2,200	0 - 3,000	3.2 (1.5)	5 (2.3)	4.7 (2.1)	8.2" (20.9)	90 / 101	14.4
W150P	3/8" square pin	150 (203)	25 - 130 (34 - 176)	0 - 2,200	0 - 3,000	3.2 (1.5)	5 (2.3)	4.7 (2.1)	8.2" (20.9)	90 / 101	14.4
W175	1/2" square	175 (237)	25 - 130 (34 - 176)	0 - 2,200	0 - 3,000	3.2 (1.5)	5 (2.3)	4.7 (2.1)	8.2" (20.9)	90 / 101	14.4
W175P	1/2" square pin	175 (237)	25 - 130 (34 - 176)	0 - 2,200	0 - 3,000	3.2 (1.5)	5 (2.3)	4.7 (2.1)	8.2" (20.9)	90 / 101	14.4
W360	1/2" square	360 (488)	25 - 280 (33 - 379)	0 - 1,650	0 - 2,200	4.8 (2.2)	7.2 (3.3)	6.2 (2.8)	9" (22.8)	90 / 101	19.2
W360P	1/2" square pin	360 (488)	25 - 280 (33 - 379)	0 - 1,650	0 - 2,200	4.8 (2.2)	7.2 (3.3)	6.2 (2.8)	9" (22.8)	90 / 101	19.2
W360-2	1/2" square 2" extended anvil	360 (488)	25 - 280 (33 - 379)	0 - 1,650	0 - 2,200	4.8 (2.2)	7.2 (3.3)	6.2 (2.8)	9" (22.8)	90 / 101	19.2

Batteries and chargers sold separately.

'P' denotes a pin-type socket retainer.

\* Tool only, does not include battery.

\*\* Weight of tool with battery.

## IQ<sup>V</sup>™ Series Batteries and Chargers



The revolutionary IQ<sup>V</sup> series cordless power system features nickel-cadmium and lithium-ion batteries — available in 7.2-volt, 14.4-volt, and 19.2-volt capacities. All of our cordless tools are compatible with both battery chemistries. Our patented IQ<sup>V</sup> Grip twist-to-lock battery mount eliminates wear and tear common to other types of mount clips and slides.

Our digitally controlled BC-10 charger can be used with every one of our batteries. Once a battery is inserted into the charger, it automatically determines chemistry, voltage, and condition, thereby optimizing the charge process.

**IQ<sup>V</sup>** TECHNOLOGY

### Nickel-cadmium batteries

Part Number	Description
N072	7.2-volt battery
N144	14.4-volt battery
N192	19.2-volt battery

#### Features and Benefits

- ▶ IQ<sup>V</sup> microprocessor-controlled battery technology optimizes battery performance to make sure you get the most power out of every volt
- ▶ Renew feature to allow usage of the full 1,000 recharge life of nickel-cadmium IQ<sup>V</sup> batteries
- ▶ Patented twist-to-lock technology firmly holds battery in place — never duct tape your battery to your tool again!

### Lithium-ion batteries

Part Number	Description
BL072	7.2-volt battery
BL144	14.4-volt battery
BL192	19.2-volt battery

#### Features and Benefits

- ▶ Industry-leading lithium-ion cell technology blows the competition away with over 1,000 real recharges
- ▶ Requiring only one cell to match the power in four nickel-cadmium / nickel-metal hydride cells, Ingersoll Rand lithium-ion batteries offer up to 35% less weight than the nickel-cadmium version
- ▶ Patented twist-to-lock technology firmly holds battery in place — never duct tape your battery to your tool again!

### Battery charger

Part Number	Description
BC10	Battery Charger

#### Features and Benefits

- ▶ Charges all IQ<sup>V</sup> batteries including all voltages
- ▶ Fully charges most batteries in less than 45 minutes
- ▶ Renew feature deep-cycle charges nickel-cadmium batteries eliminating memory effect, restoring to like-new capacity

### Battery analyzer

Part Number	Description
BT-IQV	Battery analyzer

#### Features and Benefits

- ▶ Gives instant access to status information stored on IQ<sup>V</sup> batteries
- ▶ Easy connection to PC via USB and easy-to-use software
- ▶ Simple color-coded battery rating system



## Socket Sets

Part Number	Description
<b>3/8" DRIVE</b>	
SK3H8	8-piece SAE (5/16", 3/8", 7/16", 1/2", 9/16", 5/8", 11/16", 3/4", metal tray)
SK3H8L	8-piece SAE deep (5/16", 3/8", 7/16", 1/2", 9/16", 5/8", 11/16", 3/4", metal tray)
SK3M8	8-piece metric (9 mm, 10 mm, 11 mm, 13 mm, 14 mm, 15 mm, 17 mm, 19 mm, metal tray)
SK3M8L	8-piece metric deep (9 mm, 10 mm, 11 mm, 13 mm, 14 mm, 15 mm, 17 mm, 19 mm, metal tray)
<b>1/2" DRIVE</b>	
SK4H13	13-piece SAE (7/16", 1/2", 9/16", 5/8", 11/16", 3/4", 13/16", 7/8", 15/16", 1", 1-1/16", 1-1/8", 1-1/4", metal tray)
SK4H13L	13-piece SAE deep (7/16", 1/2", 9/16", 5/8", 11/16", 3/4", 13/16", 7/8", 15/16", 1", 1-1/16", 1-1/8", 1-1/4", metal tray)
SK4M14	14-piece metric (10 mm, 11 mm, 12 mm, 13 mm, 14 mm, 15 mm, 16 mm, 17 mm, 18 mm, 19 mm, 21 mm, 22 mm, 26 mm, 27 mm, metal box)
SK4M14L	14-piece metric deep (10 mm, 11 mm, 12 mm, 13 mm, 14 mm, 15 mm, 16 mm, 17 mm, 18 mm, 19 mm, 21 mm, 22 mm, 26 mm, 27 mm, metal tray)
SK4C3F	3-piece lug nut service (3/4" x 3/16", 19 mm x 21 mm, 3" extension)
<b>3/4" DRIVE</b>	
SK6H8	8-piece SAE (1", 1-1/16", 1-1/8", 1-1/4", 1-5/16", 1-3/8", 1-7/16", 1-1/2", metal box)
SK6H8L	13-piece SAE deep (1", 1-1/16", 1-1/8", 1-1/4", 1-5/16", 1-3/8", 1-7/16", 1-1/2", metal box)
<b>1" DRIVE</b>	
SK8H8	8-piece SAE (7/8", 15/16", 1", 1-1/16", 1-1/8", 1-3/16", 1-1/4", 1-1/2", metal box)
SK8H8L	8-piece SAE deep (7/8", 15/16", 1", 1-1/16", 1-1/8", 1-3/16", 1-1/4", 1-1/2", metal box)
SK8H9T	9-piece SAE truck service (13/16" sq.; 7/8", 15/16", 1", 1-3/16", 1-1/2" hex; 1-1/16", 1-1/8", 1-1/4" deep thin wall hex, metal box)



Based on our heritage of reliability and innovation, Ingersoll Rand introduces a comprehensive line of industrial-grade sockets consistent with the quality of our best-in-class Impacttools.

### Features and benefits

Features	Benefits
A Impact-grade toughness	Designed for high-torque applications
B Chrome-molybdenum steel	Forged for high-strength durability
C Laser-etched size labeling	Enables easier identification to get the job done faster
D Electro-phosphate finish	Projects a sleeker look for higher visibility
E Backed by a lifetime warranty	Provides peace of mind with proven reliability

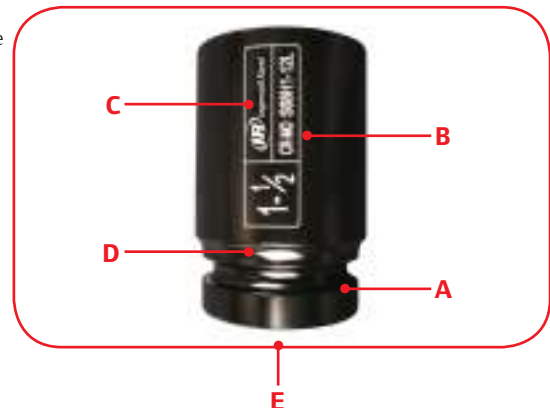

## Saws

### Reciprocating saw

- ▶ Grip-handle with self-locking throttle to promote operator safety
- ▶ Rotating exhaust deflector with muffler for quiet operation
- ▶ Heavy-duty thrust bearings for extended life
- ▶ Built-in lubricator

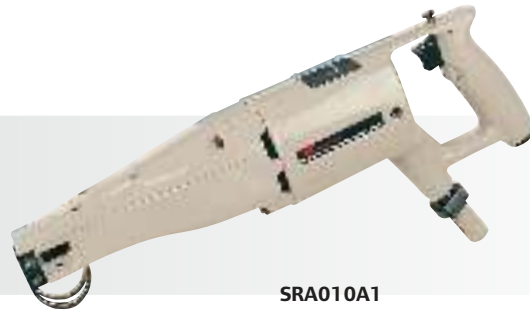

SRA010A1

Model	Strokes Per Minute	Length Of Stroke in (mm)	Length Over Front Of Saw Guide in (mm)	Weight lb (kg)	Side To Center Distance in (mm)	Max Power hp (kw)	Air Inlet Size NPT in (mm)	Size Hose Recommended in (mm)	cfm
SRA010A1	1,600	.63" (16)	17.25" (438)	8.25 (3.7)	1.63" (41)	0.65 (0.48)	1/4" (6)	5/16" (8)	21

Performance figures are at 90 psi (6.2 bar) air pressure.

Model	Kit Contents
SAW KIT	
SRA010K2	SRA010A1 saw, SB6-A blade assortment kit, SRA010A1-4 metal carrying case

### Circular saws

- ▶ Grip-handle with self-locking throttle to promote operator safety
- ▶ Exclusive self-regulating motor with patented controller for more power and less weight
- ▶ Built-in lubricator

#### S80

- ▶ Depth gauge bracket with adjustment from 3/16" to 3" (5 to 76 mm)
- ▶ 5/8" (16 mm) diameter round hub
- ▶ 8-1/4" (210 mm) diameter combination chisel tooth blade included

#### S120

- ▶ Depth gauge bracket with adjustment from 1-3/8" to 4-3/8" (35 to 111 mm)
- ▶ Pin-type blade flange
- ▶ 12" (305 mm) diameter crosscut wood sawing blade included



S80



S120

### Saw accessories

Part Number	Description	For Use With
<b>BLADES</b>		
SB6-A	Blade assortment for variety of materials (5 each 6" blades)	SRA010A1
B12-257R	12" (305mm) diameter crosscut wood sawing blade	S120
<b>OTHER ACCESSORIES</b>		
S12-A86	Abrasive blade flange kit	S120
S12-506	Depth gauge bracket for adjusting depth of cut from 0 to 4-3/8" (0 to 111 mm) with 12" (305 mm) blade	S120
SRA010A1-4	Metal carrying case	SRA010A1

Model	Free Speed rpm	Weight Without Blade lb (kg)	Max Power hp (kw)	Speed @ Max Power rpm	Blade Diameter in (mm)	Arbor Hole Diameter in (mm)	Max Depth Of Cut in (mm)	Min Depth Of Vertical Cut in (mm)	cfm
S80	4,000	14.5 (6.6)	2 (1.49)	2,500	8.25" (210)	5/8" (16)	3" (76)	0.18" (5)	67
S120	2,050	27.25 (12.4)	3.2 (2.4)	1,400	12" (305)	1" (25)	4.38" (111)	1.38" (35)	93

Model	Size Of Shoe in (mm)	Max Depth Of Cut @ 45° Angle in (mm)	Max Thickness Of Material For 45° Cut in (mm)	Length in (mm)	Width in (mm)	Distance From Blade To End Of Motor Casing in (mm)	Distance From Center Of Blade To Front Of Shoe in (mm)	NPT Air Inlet in	Size Hose Recommended in (mm)
S80	7.88" x 12" (200 x 305)	2.5" (64)	1.75" (102)	13.75" (350)	8.75" (222)	5.88" (149)	1.88" (48)	1/2"	3/4" (19)
S120	8.5" x 18.5" (216 x 470)	4" (45)	2.88" (73)	19.88" (505)	10.31" (262)	8.31" (211)	8.31" (211)	1/2"	3/4" (19)

Performance figures are at 90 psi (6.2 bar) air pressure.

## Large Drills



Model	Free Speed rpm	Capacity In Drilling in (mm)	Steel Reaming in (mm)	Spindle	Spindle Attachment	Max Power hp (kw)	Length Of Feed in (mm)	Weight lb (kg)	Height Over Spindle in (mm)	Side To Center Distance in (mm)	Inlet Size in	cfm	NPT Air Recommended Size Hose in (mm)
22JA1	1,025	916" (14)	38" (10)	Stub taper, threaded chuck	564-12"	1.75 (1.31)	2.5" (63)	15 (6.8)	16.38" (416)	1.44" (36)	55	1/2"	3/4" (19)
22KA1	725	916" (14)	716" (11)	Stub taper, threaded chuck	564-12"	1.75 (1.31)	2.5" (63)	15.25 (6.92)	17.63" (448)	1.44" (36)	55	1/2"	3/4" (19)
22MA2	350	78" (22)	58" (16)	No. 2 Morse taper	N/A	1.75 (1.31)	2.5" (63)	14.25 (6.46)	18.63" (473)	1.44" (36)	55	1/2"	3/4" (19)
22NA1	280	78" (22)	58" (16)	Stub taper, threaded drive	58" square	1.65 (1.23)	2.5" (63)	16.5 (7.48)	20.38" (517)	1.44" (36)	55	1/2"	3/4" (19)
22KWA1	725	N/A	N/A	Stub taper, threaded wood	1/2" shank	1.75 (1.31)	2.5" (63)	14.25 (6.46)	17.25" (438)	1.44" (36)	55	1/2"	3/4" (19)
33SJA	450	1" (25)	1516" (24)	No. 3 Morse taper	N/A	3.0 (2.24)	4.25" (108)	25.75 (11.7)	14" (355)	1.88" (47)	85	1/2"	3/4" (19)
33SKA	300	1-1/4" (32)	1" (25)	No. 3 Morse taper	N/A	3.0 (2.24)	4.25" (108)	25.75 (11.7)	14" (355)	1.88" (47)	85	1/2"	3/4" (19)
33SMA	185	1-1/4" (32)	1-1/4" (32)	No. 3 Morse taper	N/A	2.9 (2.16)	4.25" (108)	31 (14.1)	16.81" (427)	1.94" (49)	85	1/2"	3/4" (19)
44SMA	155	2" (51)	2" (51)	No. 4 Morse taper	N/A	3.6 (2.69)	4.25" (108)	43.75 (19.8)	18.25" (463)	2.31" (59)	102	1/2"	3/4" (19)
551SMA	120	3" (76)	2-1/2" (64)	No. 5 Morse taper	N/A	5.6 (4.18)	5" (127)	69 (31.3)	21.88" (556)	2.94" (75)	160	1"	1" (25)
551SOA	77	Heavy	Heavy	No. 5 Morse taper	N/A	5.6 (4.18)	5" (127)	69.5 (31.5)	21.88" (556)	2.94" (75)	160	1"	1" (25)

Performance figures are at 90 psi (6.2 bar) air pressure.

## Large Drill Accessories

Part Number	Description	For Use With
<b>SQUARE DRIVE SOCKET ADAPTER</b>		
DE-215A	1/2" square drive socket adapter	22 Series
<b>NUTS / CHUCKS</b>		
DE-99C	3-jaw key chuck	22 Series
T05-99A	3-jaw key chuck	22 Series
T12-347	Chuck nut	33 Series
TA-461	Nut	551 Series
<b>MORSE TAPER SOCKET</b>		
DE-323A-2	No. 2 Morse taper socket	22 Series
<b>WOOD BIT CHUCKS AND ACCESSORIES</b>		
K-27	Wood bit chuck wrench	22 Series
R33SW-151-1/2	Wood bit chuck	33 Series
TA-A291	Wood bit chuck assembly	551 Series
<b>LARGE DRILL ACCESSORIES</b>		
TC-365	Suspension ring	33 Series
TC-461	Feed screw cover	33 Series



# Grinders and Surface Preparation Tools

## G-Series

Engineered and built with Ingersoll Rand reliability and durability, the G-Series has the features operators want most, including ergonomic D-shaped handle for operator comfort, one-nut access for easy motor servicing, and changeable front / rear exhaust for versatility.



**G1H250RG4**

- ▶ 0.4-hp motor
- ▶ Ideal for light material removal
- ▶ Low noise and vibration
- ▶ Air inlet is 1/4" NPT and recommended hose size is 3/8"



**G2E135RP64**

- ▶ 0.8-hp motor
- ▶ Great for general finishing work
- ▶ Extended-angle configuration
- ▶ Air inlet is 1/4" NPT and recommended hose size is 3/8"



**G3A100RP106**

- ▶ 1.35-hp motor
- ▶ Well equipped for heavier material removal
- ▶ Vibration-reducing handle
- ▶ Internal contamination-free air controller
- ▶ Air inlet is 3/8" NPT and recommended hose size is 1/2"

Model	Configuration	Rated Power hp	Free Speed rpm	Exhaust	Output	Wheel Type	Weight lb (kg)	Overall Length in (mm)	Height Over Spindle End in (mm)	Airflow cfm
<b>G-SERIES</b>										
G1A200RG4	Horizontal	0.4	20,000	Rear	1/4" collet	N/A	1.1 (0.5)	6" (152)	3" (76)	25
G1H250RG4	Horizontal	0.4	25,000	Rear	1/4" collet	N/A	0.9 (0.4)	6.13" (155)	N/A	20
G2H250RG4	Horizontal	0.8	25,000	Rear	1/4" collet	N/A	1.6 (0.7)	7.38" (187)	N/A	36
G2H180RG4	Horizontal	0.8	18,000	Rear	1/4" collet	N/A	1.6 (0.7)	7.38" (187)	N/A	36
G2E135RP64	Extended angle	0.8	13,500	Rear	3/8"-24 thread, 4" guard	27, 28	3 (1.3)	10.38" (263)	2.63" (66)	36
G3A120RP105	Angle	1.35	12,000	Rear	5/8"-11 thread, 5" guard	27, 28	4.7 (2.1)	9.63" (244)	3.63" (92)	55
G3A120RP1045	Angle	1.35	12,000	Rear	5/8"-11 thread, 4.5" guard	27, 28	4.6 (2)	9.63" (244)	3.63" (92)	55
G3A100RP106	Angle	1.35	10,000	Rear	5/8"-11 thread, 6" guard	27, 28	4.9 (2.2)	9.63" (244)	3.63" (92)	33

Performance figures are at 90 psi (6.2 bar) air pressure.

## Pro-Series™

Designed for the heaviest-duty applications, our Pro-Series grinders deliver superior performance by removing up to 25 percent more material while reducing air consumption by up to one-third over competitive models. The patented stainless-steel motor controller is maintenance-free with the industry's only lifetime guarantee.



**77A60P109**

- ▶ 1.5-hp motor
- ▶ Low-profile angle head for close-quarter applications
- ▶ Air inlet is 3/8" NPT and recommended hose size is 1/2"



**88S60W107**

- ▶ 2-hp motor
- ▶ 7" back-up pad
- ▶ Air inlet is 1/2" NPT and recommended hose size is 3/4"



**99V60S106**

- ▶ 3-hp motor
- ▶ Air inlet is 1/2" NPT and recommended hose size is 3/4"

Model	Configuration	Rated Power hp	Free Speed rpm	Standard Spindle	Guard Size	Wheel Type	Weight lb (kg)	Height Over End Of Spindle in (mm)	Side To Center Distance Of Spindle in (mm)	cfm
<b>PRO SERIES</b>										
77A60P109	Angle	1.5	6,000	5/8" - 11 thread	9"	27, 28	9.19 (4.17)	3.88" (98)	1.31" (33.4)	39
88V60P107	Vertical	2.0	6,000	5/8" - 11 thread	7"	27, 28	8.75 (3.97)	6.09" (154.9)	2.13" (54)	61
88S60W107	Vertical	2	6,000	5/8" - 11 thread	7"	N/A	7.13 (3.23)	6" (152.4)	2.13" (54)	61
99V60S106	Vertical	3	6,000	5/8" - 11 thread	6"	6, 11	10.75 (4.88)	6.88" (174.6)	2.31" (58.7)	84
99V60P109	Vertical	3	6,000	5/8" - 11 thread	9"	27, 28	1.94 (0.88)	6.88" (174.6)	2.31" (58.7)	84

Performance figures are at 90 psi (6.2 bar) air pressure.

## Type 27 and 28 Wheel Accessories

Description	77A Series	88V Series	99V Series
6" type 6 or 11 cup wheel guard	N/A	88V60-A216	99V60-A216A
Piped-away exhaust kit	N/A	88V60-K184	99V60-K184
Wheel retaining screw wrench	88V-562	88V-562	88V-562
Controller wrench	77H-950	88V60-950	99V60-950
Comfort grips	N/A	CG-88V	CG-99V

For use with Type 27 plain-hole depressed center wheels.

## Type 6 and 11 Wheel Accessories

Description	88V Series	Series 99V
7" type 27 wheel guard	88V60-106-7	99V77-106-7
9" type 27 wheel guard	88V60-106-9	99V60-106-9
7" and 9" type 27 wheel adapter kit*	R3F-AS337	R3F-AS337
Piped-away exhaust kit	88V60-K184	99V60-K184
Wheel retaining screw wrench	88V-562	88V-562
Controller wrench	88V60-950	99V60-950
Comfort grips	CG-88V	CG-99V

\*For use with Type 27 plain-hole depressed center wheels.



## Carbide Burr Kits

Part Number	Description	Contents
1438TIN	6-piece carbide burr kit	6-TiN coated carbide burrs — 1/4" shank with assorted 3/8" head diameter burrs with soft-sided case
614TIN	6-piece carbide burr kit	6-TiN coated carbide burrs — 1/4" shank with assorted 1/2" and 3/8" head diameter burrs with soft-sided case
1412TIN	6-piece carbide burr kit	6-TiN coated carbide burrs — 1/4" shank with assorted 1/2" head diameter burrs with soft-sided case
814TIN	8-piece carbide burr kit	8-TiN coated carbide burrs — 1/4" shank with assorted 1/2" and 3/8" head diameter burrs includes hard case

For more accessories, please visit [irtools.com](http://irtools.com).

## Quick Change Backer Pads

Part Number	Description
02A-MEDPD	2" medium holder pad — 1/4" mandrel
03A-MEDPD	3" medium holder pad — 1/4" mandrel

## Quick Change Surface Prep Discs

Part Number	Description
<b>INDUSTRIAL PACKS (FLAP-TOP BOX)</b>	
15A-CRSBR-50	1-1/2" surface prep disc — coarse, brown
15A-MEDBR-50	1-1/2" surface prep disc — medium, maroon
15A-VFNBR-50	1-1/2" surface prep disc — very fine, blue
02A-CRSBR-50	2" surface prep disc — coarse, brown
02A-MEDBR-50	2" surface prep disc — medium, maroon
02A-VFNBR-50	2" surface prep disc — very fine, blue
03A-CRSBR-25	3" surface prep disc — coarse, brown
03A-MEDBR-25	3" surface prep disc — medium, maroon
03A-VFNBR-25	3" surface prep disc — very fine, blue
<b>AUTOMOTIVE PACKS (SMALLER QUANTITY FLIP-TOP)</b>	
02A-CRSBR-25	2" surface prep disc — coarse, brown
02A-MEDBR-25	2" surface prep disc — medium, maroon
02A-VFNBR-25	2" surface prep disc — very fine, blue
03A-CRSBR-10	3" surface prep disc — coarse, brown
03A-MEDBR-10	3" surface prep disc — medium, maroon
03A-VFNBR-10	3" surface prep disc — very fine, blue
02A-036AO-25	2" AO Series sanding disc — 36 grit
02A-050AO-25	2" AO Series sanding disc — 50 grit
03A-036AO-25	3" AO Series sanding disc — 36 grit
03A-050AO-25	3" AO Series sanding disc — 50 grit



## Needle and Chisel Scalers



Model	Handle Description	Stroke in (mm)	Bore in (mm)	Weight lb (kg)	Length in (mm)	bpm	cfm	Inlet Size NPT in	Recommended Hose Size in (mm)
<b>NEEDLE SCALERS</b>									
172LNA1	In-line	0.56" (14)	0.88" (24)	5.25 (2.38)	13.75" (349)	5,500	12	1/4"	5/16" (8)
182LNA1	In-line	1.06" (27)	0.88" (24)	5.75 (2.61)	15" (381)	4,000	13	1/4"	5/16" (8)
170PG	Pistol grip	1.4" (35.6)	0.925" (23.5)	6.62 (3.00)	12.4" (315)	3,000	5.5	1/4"	5/16" (8)
180PG	Pistol grip	1.54" (39.1)	1.125" (28.6)	8.88 (4.03)	13.5" (343)	2,200	8	1/4"	5/16" (8)
<b>CHISEL SCALERS</b>									
172L	In-line	0.56" (14)	0.88" (24)	3.69 (1.69)	7.63" (194)	5,500	12	1/4"	5/16" (8)
182G	Swan neck	1.06" (27)	0.88" (24)	5.31 (2.41)	12.81" (325)	4,000	13	1/4"	5/16" (8)
182L	In-line	1.06" (27)	0.88" (24)	4.06 (1.84)	9" (229)	4,000	13	1/4"	5/16" (8)
170PG-CS	Pistol grip	1.4" (35)	0.93" (23)	5.32 (2.4)	12.4" (314)	3,000	5.5	1/4"	5/16" (8)
180PG-CS*	Pistol grip	1.54" (39)	1.13" (28)	6.81 (3.1)	12.4" (314)	2,200	8	1/4"	5/16" (8)

\*5/8" hex shank chisel holder/retainer (p/n 22039705) is available for 180PG-CS.



Model	Kit Contents
<b>Scaler Kits</b>	
182K1	182L needle scaler, the 5" needle housing, 2 needle packs (5" and 7" long) and 3 chisels; there are 19 needles per pack made of carbon steel; the chisels included are one each of the following: 7" flat scaling chisel, 6" angle scaling chisel, and a 6" straight scaling chisel
170PG-KIT	170PG needle scaler, 1/2" shank chisel holder, 3 needle packs and 3 chisels; needles included are one pack each of chisel tip, pointed tip, and flat tip 3 mm needles, with 19 needles per pack; needles are 7" long and made of carbon steel; chisels included are one each of 1/2" square, 7" long chisels: 3/4" flat, 1-3/8" offset (weld flux), and 2" flat chisel
180PG-KIT	180PG needle scaler, 1/2" shank chisel holder, 3 needle packs and 3 chisels; needles included are one pack each of chisel tip, pointed tip, and flat tip 3 mm needles, with 28 needles per pack; needles are 7" long and made of carbon steel; chisels included are one each of 1/2" square, 7" long chisels: 3/4" flat, 1-3/8" offset (weld flux), and 2" flat chisel

## Scaler Accessories

### Scaler needles

Part Number	Tip	Length in	Product	Quantity
<b>2 MM</b>				
22038525	Flat	7"	Carbon steel	100
<b>3 MM</b>				
NS11-22-19	Flat	5"	Carbon steel	19
NS11-B22-19	Flat	5"	Beryllium copper	19
NS11-S22-19	Flat	5"	Stainless steel	19
NS11-122-19	Flat	7"	Carbon steel	19
22038533	Flat	5"	Carbon steel	100
89940597	Flat	7"	Carbon steel	100
22038541	Flat	7"	Carbon steel	1,000
22038558	Flat	7"	Beryllium copper	100
22038566	Flat	7"	Beryllium copper	500
22038574	Chisel	7"	Carbon steel	100
22038582	Chisel	7"	Carbon steel	1,000
22038590	Pointed	7"	Carbon steel	100
22038608	Pointed	7"	Carbon steel	1,000
<b>4 MM</b>				
22038616	Flat	7"	Carbon steel	100
22038624	Flat	7"	Carbon steel	500
22038632	Chisel	7"	Carbon steel	100
22038640	Chisel	7"	Carbon steel	500
22038657	Pointed	7"	Carbon steel	100
22038665	Pointed	7"	Carbon steel	500

### Needle holder\* for pistol grip scalers

Part Number	For Use With
<b>2 MM</b>	
22038194	170PG
22038202	180PG
<b>4 MM</b>	
22038210	180PG

\*Does not include needles.



### Needle housings for in-line scalers

Round Needle Housings	With	For Use
NS11A	5" (127 mm) steel needles	172L, 182L, 182G
NS11AS	5" (127 mm) stainless steel needles	172L, 182L, 182G
NS11A7	7" (178 mm) extended steel needles	172L, 182L, 182G
<b>Rectangular Needle Housings With</b>		
NS11BB	5" (127 mm) beryllium copper needles	172L, 182L, 182G
NS11BS	5" (127 mm) stainless steel needles	172L, 182L, 182G
NS11B7	7" (178 mm) extended steel needles	172L, 182L, 182G

### Scaler chisels (1/2" square shank)

Part Number	Type	Overall Length in	Blade Width in
89940613	Straight scaling	7"	2"
22038749	Straight scaling	7"	3"
22038756	Straight scaling (spark-resistant)	7"	2"
WF-14F-7	Flat scaling	7"	3/4"
WF-14-007	Blank	7"	N/A
WF-14G-6	Gouge	6"	5/8"
WF-14B-007	Scaling chisel	7"	1-3/8"
WF-14B-012	Scaling chisel	12"	1-3/8"
WF-14A-007	Angle chisel	7"	1-3/8"
WF-14A-12	Angle chisel	12"	1-3/8"
WF-14C-007	Wide chisel	7"	2"
WF-14C-012	Wide chisel	12"	2"
WF-14D-007	Wide chisel	7"	3"
WF-14D-012	Wide chisel	12"	3"

For our complete offering of scaler needles, chisels, and accessories, please see the Ingersoll Rand Construction Tool Steels and Accessories catalog, Form # IRPS-0407-006.

# De-watering Pumps

- ▶ Simple design
- ▶ Few moving parts
- ▶ Direct-drive, multi-vane air motor
- ▶ Self-priming
- ▶ Patented speed controller
- ▶ Closed-type impeller
- ▶ Basket-style inlet strainer cover
- ▶ Available in 2" and 2-1/2" discharge



P237A1-EU

Flow Chart (centrifugal)

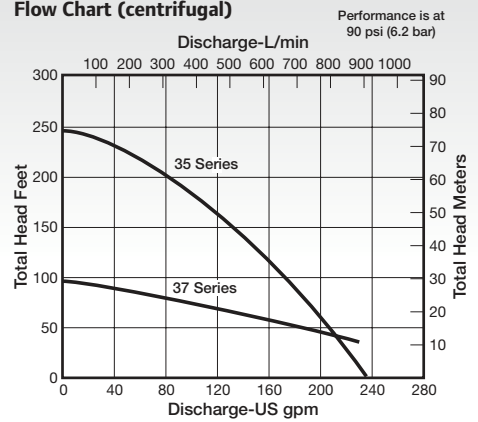

Centrifugal

Model	Height in (mm)	Weight lb (kg)	Opening Pump Will Pass Through in (mm)	Discharge Pipe Tap NPT in	Air Inlet Size		Exhaust Size		cfm
					Pipe Tap NPT in	Recommended Hose in (mm)	Pipe Tap NPT in	Recommended Hose in (mm)	
P237A1-EU	17-5/8" (448)	48 (21.8)	8-3/4" x 8-3/4" (222 x 222)	2-1/2"	3/4"	3/4" (19)	1-1/4"	1-1/4" (32)	100
P35A1-EU	22-1/2" (570)	79 (36)	8-7/16" x 14-1/16" (214 x 357)	2"	1"	1" (25)	1-1/4"	1-1/4" (32)	160

# Hoists and Winches



Pullers	36
Lever and Manual Chain Hoists	37
VL2 Premium Series Manual Chain Hoists	38
Winches	39
BC-Series Beam Clamps	41

# Pullers

- ▶ 4:1 design factor meets ASME B30.21
- ▶ Handle and frame are heavy-gauge steel with rivet construction and slip-resistant grip; all steel parts are plated for years of useful life
- ▶ Exclusive long-life buttress tooth cast gear design has no laminated plates to separate or wear, providing maximum strength
- ▶ Sturdy steel drive and holding pawls have long life, stainless-steel springs; pivot points are hardened steel
- ▶ Safety latch hooks are drop-forged steel, heat-treated, and plated for corrosion resistance; top hook rotates 360° for easy operation
- ▶ Cast-aluminum drum has a “through-the-drum” anchor, larger diameter, and a drum guard so wire rope won’t come loose; the guard also bends less so it lasts longer and spools evenly while rewinding
- ▶ Galvanized, aircraft-quality wire rope is preformed to prevent kinks
- ▶ One-year warranty



P15D3H

Model	Number Of Lines	Rated Capacity Lifting 4:1 lb	Min Distance Between Hooks in	Lifting Distance ft	Cable Diameter in	Number Of Hooks	Net Weight lb
P15H	Single	1,000	19-1/2"	15'	3/16"	2	8
P15D3H	Single	1,000	21"	15'	3/16"	3	10
	Double	2,000	27-1/2"	7-1/2'	3/16"	3	10

- ▶ 4:1 design factor lifting, lowering, and pulling meets ASME B30.21
- ▶ Lightweight aluminum frame
- ▶ Alloy steel load hook with safety latches
- ▶ One-piece cast aluminum drum
- ▶ Buttress tooth design improves load gear life
- ▶ Solid steel drive and holding dog, not laminated plates
- ▶ Galvanized, aircraft-quality wire rope
- ▶ Ratchet and pawl system provides safe, one-notch-at-a-time lowering
- ▶ Large drum stores up to 38 feet of wire rope
- ▶ Cable guide and shield protects wire rope and spools cable evenly on drum
- ▶ Reversible handle changes position easily, so pull is always possible in the right direction against the load
- ▶ Plated external parts for corrosion resistance
- ▶ Three hooks allow a 2-ton capacity and a 6" pull with a double line, and a 1-ton capacity with a 12' pull using a single line
- ▶ Non-conductive, corrosion-resistant, high-strength synthetic strap will not kink or bind
- ▶ Easy payout of strap for fast set-up



C400S

C400H

Model	Number Of Lines	Rated Capacity Lifting 4:1 lb	Min Distance Between Hooks in	Lifting Distance ft	Cable Diameter in	Number Of Hooks	Net Weight lb
C400H	Single	1,700	17"	20'	1/4"	2	16
	Double	3,400	22"	10'	1/4"	3	16
C400S	Single	2,000	17"	12'	3/32" x 1-7/8"	2	16
	Double	4,000	22"	6'	3/32" x 1-7/8"	3	16

## Lever and Manual Chain Hoists

- ▶ Deep lug knobs for easy one-handed operation with or without gloves
- ▶ Open frame design for easy cleaning and inspection
- ▶ All-steel construction
- ▶ 360° handle rotation
- ▶ Reliable disc brake
- ▶ Premium-grade 100 alloy load chain
- ▶ Hardened swivel-latch hooks
- ▶ Low handle force
- ▶ Short handle stroke
- ▶ Standard lifts of 5, 10, 15, and 20 feet; longer lifts available



SLB150

Model	Capacity Metric tons (lb)	Pull To Lift Rated Load lb	Net Weight Of Chain Per ft Of Lift lb	Number Of Chain Falls	Load Chain Size mm	Ship Weight With 5 ft Of Lift lb	Min Head Room in
SLB150	3/4 (1,650)	41	0.53	1	6 x 18	16	13"
SLB200	1 (2,200)	60	0.53	1	6 x 18	16	14.4"
SLB300	1-1/2 (3,300)	53	11.73	1	7.1 x 21.2	25	15.7"
SLB600	3 (6,600)	53	1.48	1	10 x 30	47	20.5"
SLB1200	6 (13,200)	57	2.95	2	10 x 30	74	25.2"

### Part Number Configuration

Model Number	-	Lift Length	
SLB150	-	X	5 = 5 ft 10 = 10 ft 15 = 15 ft 20 = 20 ft XX = user-specified

- ▶ Overload protection to reduce downtime and repair costs
- ▶ All-steel, low headroom, lightweight construction
- ▶ Self-adjusting, disc-type double-pawl, mechanical-load brake
- ▶ Ideally suited for the rental and construction markets
- ▶ Standard lift is 10', hand chain drop is 2' less than lift (unless specified)
- ▶ Open frame design for easy cleaning and inspection
- ▶ Double hand chain guides for smooth operation when pulling excess hand chain
- ▶ Encased and retained roller bearings for increased efficiency and ease of maintenance
- ▶ Nickel / chrome-plated exterior and zinc-plated frame components for increased corrosion resistance



SMB010

Model	Capacity Metric tons (lb)	Pull To Lift Rated Load lb	Chain Overhauled To Lift Load 1 ft	Net Weight Of Chain Per ft Of Lift lb	Number Of Chain Falls	Load Chain Size mm	Ship Weight With 10 ft Lift lb	Min Head Room in
SMB005	1/2 (1,100)	55.5	31.5	0.36	1	5 x 15	23.5	12.8"
SMB010	1 (2,200)	64	53.1	0.53	1	6 x 18	26.8	13.8"
SMB015	1-1/2 (3,300)	69	71.6	0.74	1	7.1 x 21	38.5	17.1"
SMB020	2 (4,400)	77	84.6	1.03	1	8 x 24.6	42.4	18.2"
SMB030	3 (6,600)	100	99.4	1.45	1	10 x 30	70.4	20.9"
SMB050	5 (11,000)	83.5	213.2	1.19	2	9 x 27.2	90.2	28"

### Part Number Configuration

Model Number	-	Lift Length	-	Hand Chain Drop V	
SMB005	-	X	-	X	8 V = 8 ft 13 V = 13 ft 18 V = 18 ft XX = user-specified
					10 = 10 ft 15 = 15 ft 20 = 20 ft XX = user-specified

# VL2 Premium Series Manual Chain Hoists



- ▶ Accu-Feed™ hand chain guide articulates for smooth operation from either side, away from load being lifted
- ▶ All-steel construction for external impact resistance
- ▶ Forged steel alloy load hooks with non-slip design have extra wide throat openings for easy rigging
- ▶ Premium alloy steel-grade 100 load chain
- ▶ Thrust-bearing bottom block on 3-ton and above helps prevent chain twisting or kinking
- ▶ Chain anchor prevents jamming at the hook's lowest position
- ▶ Needle bearings reduce friction and provide low hand chain pull
- ▶ Overload protection to reduce downtime and repair costs
- ▶ Available in standard lifts of 10, 15, and 20 feet; hand chain is 2 feet less than lift

### Options

- ▶ Spark- and corrosion-resistant models
- ▶ Spark- and corrosion-resistant load and hand chain
- ▶ Non-standard lifts
- ▶ Chain buckets
- ▶ Protective coatings



Nylon-bushed VL2 hoist hand chain guide. Zinc-plated hand chain shown.

VL2-010

Model	Capacity Metric tons (lb)	Pull To Lift Rated Load lb	Chain Overhauled To Lift Load 1 ft	Net Weight Of Chain Per ft. Of Lift lb	Number Of Chain Falls	Load Chain Size mm	Ship Weight With 10 ft. Of Lift lb
VL2-005	1/2 (1,100)	55	25	0.356	1	5 x 15	20
VL2-010	1 (2,200)	73	28	0.569	1	6.3 x 19.2	26
VL2-015	1-1/2 (3,300)	74	57	0.744	1	7.1 x 21.2	45
VL2-020	2 (4,400)	76	73	1.03	1	8 x 24.2	50
VL2-030	3 (6,600)	76	112	1.488	2	7.1 x 21.2	52
VL2-050	5 (11,000)	85	181	2.38	2	9 x 27.2	94
VL2-080	8 (17,600)	90	272	3.57	3	9 x 27.2	150
VL2-100	10 (22,000)	90	362	4.76	4	9 x 27.2	188
VL2-150	15 (33,000)	2 x 90	2 x 272	7.14	6	9 x 27.2	395
VL2-200	20 (44,000)	2 x 90	2 x 362	9.52	8	9 x 27.2	485

Model	A (min)	B	C	D
VL2-005	12"	5-11/16"	5"	1-1/16"
VL2-010	13-5/8"	6-3/16"	5-13/16"	13/16"
VL2-015	14-5/8"	6-7/8"	5-13/16"	1-11/32"
VL2-020	16-3/4"	8"	7-1/16"	1-15/32"
VL2-030	19-7/8"	8-7/8"	5-13/16"	11-9/32"
VL2-050	25"	10-3/8"	7-1/16"	1-7/8"
VL2-080	29-1/8"	13-5/8"	7-1/16"	2-5/8"
VL2-100	29-15/16"	14-7/16"	7-1/16"	2-5/8"
VL2-150	33-1/2"	29-3/8"	8-3/16"	3-7/16"
VL2-200	34-1/4"	34-3/8"	8-3/16"	3-7/16"

Dimensions are in inches.

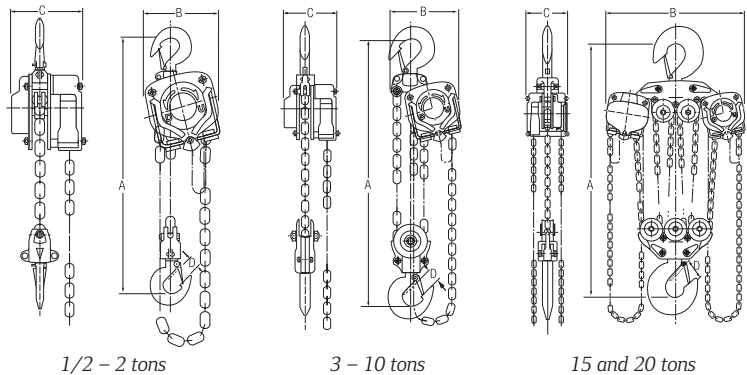

### Part Number Configuration

Model Number	Lift Length	Hand Chain Drop V	
VL2-005	X	X	8 V = 8 ft 13 V = 13 ft 18 V = 18 ft XX = user-specified
			10 = 10 ft 15 = 15 ft 20 = 20 ft XX = user-specified

## Winches

- ▶ Ideal in hot, dirty, and wet environments
- ▶ Run cool and can be stalled without damage
- ▶ Throttles vary pressure and flow for excellent speed and load control
- ▶ Disengaging clutches on select models allow free spooling of unloaded wire rope



BU7A

Utility Model	ASME B30.7 Allowable Rated Line Pulls With Design Factor Lifting (5:1 DF) lb (kg)	ASME B30.7 Allowable Rated Line Pulls With Design Factor Pulling (3:5:1 DF) lb (kg)	Max Stall Pull lb	Rated Lift Capacity kg	Clutch	Standard Cable Payout
BU7A <sup>3</sup>	1,000 (454)	1,200 (545)	1,950 (886)	Mid layer	Standard	Overwound
PS2-1000R <sup>3</sup>	1,320 (600)	2,200 (1000)	2,475 (1125)	First layer	Standard	Overwound
EU <sup>3</sup>	2,000 (909)	2,855 (1298)	4,500 (2045)	Mid layer	Standard	Overwound
PS2400R <sup>3</sup>	3,300 (1500)	5,280 (2400)	4,500 (2045)	First layer	Standard	Underwound
FA2B	4,000 (1818)	4,000 (1818)	6,800 (3084)	Mid layer	Option	Overwound
FA2BMR <sup>4</sup>	2,500 (1136)	4,000 (1818)	6,800 (3084)	Mid layer	Option	Overwound
FA5A	10,000 (4545)	14,285 (6493)	17,000 (7727)	Mid layer	Option	Overwound

Air Winch Series	Lifting Capacity lb <sup>1</sup> (kg <sup>1</sup> )	Line Speed fpm (m/min)	Recommended Rope Size <sup>2</sup>		Drum Root Diameter in (mm)	Motor hp	Average Required scfm (m <sup>3</sup> /min)	Pipe Inlet Size in	Hose Size Diameter in	Rope Anchor Hole in	Recommended Portable Compressor
			15:1 in (mm)	18:1 in (mm)							
BU7A <sup>3</sup>	1,000 (455)	43 (13)	1/4" (6.5)	1/4" (6.5)	4-1/2" (114)	1.6	50 (1.4)	1/2"	3/4"	11/32"	P185
PS2-1000R <sup>3</sup>	N/A	15 (4.6)	1/4" (6.5)	5/16" (8)	5-1/2" (140)	2	78 (2.2)	1/2"	3/4"	3/8"	P185
EU <sup>3</sup>	2,000 (909)	55 (17)	3/8" (10)	3/8" (10)	6" (152)	4.4	100 (2.8)	3/4"	1"	9/16"	P185
PS2400R <sup>3</sup>	N/A	12 (3.7)	3/8" (10)	3/8" (10)	7-3/32" (180)	3.3	125 (3.5)	3/4"	3/4"	10 mm	P185
FA2B	4,000 (1818)	122 (37)	5/8" (16)	1/2" (13)	9-1/4" (235)	16	350 (9.9)	1-1/4"	1-1/4"	5/8"	P185, P250
FA2BMR <sup>4</sup>	2,500 (1136)	168 (51)	5/8" (16)	1/2" (13)	9-1/4" (235)	15	380 (10.8)	1-1/4"	1-1/2"	5/8"	P185, P250
FA5A	10,000 (4545)	60 (18)	7/8" (22)	3/4" (19)	12-3/4" (324)	25	700 (20)	1-1/4"	1-1/2"	3/4"	P375, P600

<sup>1</sup> Lifting capacity rating complies with ASME B30.7 for base-mounted drum hoists. Provides 5:1 design factor based on the rated line pull for lifting.

<sup>2</sup> Extra improved plow steel IWRC wire rope.

<sup>3</sup> The BU7A, EU, PS1000R, and PS2400R are fitted as standard with a free spool clutch. These winches can be used for lifting at the capacity shown to maintain 5:1 DF only in those countries that allow it.

<sup>4</sup> DF 8:1.



### Wire ropes

Rope Size in (mm)	Breaking Strength lb <sup>1</sup> (kg <sup>1</sup> )	Weight lb/ft (kg/m)	Recommended Safe Pulling 3.5:1 <sup>2</sup> lb (kg)	Working Loads Lifting / Lowering 5:1 <sup>2</sup> lb (kg)
1/4" (6)	5,880 (2672)	0.11 (0.16)	1,680 (764)	1,176 (534)
5/16" (8)	9,160 (4163)	0.18 (0.27)	2,616 (1189)	1,832 (833)
3/8" (9)	13,120 (5963)	0.26 (0.39)	3,748 (1704)	2,624 (1193)
7/16" (12)	17,780 (8081)	0.35 (0.52)	5,080 (2309)	3,556 (1616)
1/2" (13)	23,000 (10454)	0.46 (0.69)	6,570 (2986)	4,600 (2091)
5/8" (15)	35,800 (16271)	0.72 (1.07)	10,228 (4649)	7,160 (3255)
3/4" (19)	51,200 (23270)	1.04 (1.55)	14,628 (6649)	10,240 (4655)
7/8" (22)	69,200 (31451)	1.42 (2.12)	19,771 (8987)	13,840 (6291)
1" (25)	89,800 (40814)	1.85 (2.76)	25,657 (11662)	17,960 (8164)
1-1/8" (28)	113,000 (51359)	2.34 (3.49)	32,286 (14675)	22,600 (10273)

<sup>1</sup> Based on improved plow steel wire rope with independent wire rope core.

<sup>2</sup> Regarding ropes, ASME B30.7 requires a minimum of 3.5:1 design factor with 15:1 rope pitch diameter to drum diameter for most winching applications. For lifting and lowering a 5:1 design factor with an 18:1 rope pitch diameter to drum diameter is required.

### Kits and accessories

Model	Drum Guard	Air Strainer	Lubricator	Muffler <sup>1</sup>
BU7A	BU7A-K298A	EU-A267 (34")	L30-06-000	50592
EU	EU-K298A	EU-A267 (34")	L30-06-000	50592
PS2-1000RGC-L	7618-0059	EU-A267 (34")	L30-06-000	Built-in
PS2400RGC-L	76310027	EU-A267 (34")	L30-06-000	Built-in
FA2B-20MX1	26317-3	K4U-A267AT (1-1/4")	L40-OB-G00 (1-1/2")	71297469
FA2BMR	26317-3	K4U-A267AT (1-1/4")	L40-OB-G00 (1-1/2")	71297469
FA5A-24MX1	23507	ST900-267-24 (1-1/2")	L40-OB-G00 (1-1/2")	71297469

<sup>1</sup> Customer supplies fittings.

<sup>2</sup> For assembled drum guard add "G" to the end of model number.

### Drum wire rope storage capacities

Model	Capacity lb (kg)	Max Length On Winch (tightly wound)						
		1/4" ft (m)	5/16" ft (m)	3/8" ft (m)	7/16" ft (m)	1/2" ft (m)	5/8" ft (m)	3/4" ft (m)
BU7A	1,000 (454)	228' (70)	132' (40)	N/A	N/A	N/A	N/A	N/A
PS2-1000RGC-L	1,320 (600)	600' (183)	335' (102)	N/A	N/A	N/A	N/A	N/A
EU	2,000 (909)	N/A	339' (108)	220' (67)	164' (50)	N/A	N/A	N/A
PS2400RGC-L	3,300 (1500)	N/A	593' (181)	394' (120)	N/A	N/A	N/A	N/A
FA2B-20MX1	4,000 (1818)	N/A	N/A	1,758' (536)	1,371' (418)	1,068' (326)	625' (191)	N/A
FA2BMR	2,500 (1136)	N/A	N/A	1,758' (536)	1,371' (418)	1,068' (326)	625' (191)	N/A
FA5A-24MX1	10,000 (4545)	N/A	N/A	N/A	N/A	N/A	1,833' (559)	1,200' (366)



PS2400RGC-L



FA5A-LMX1

## BC-Series Beam Clamps

1 to 10 metric ton capacity

- ▶ Quick installation by hand
- ▶ Low headroom design fits a wide range of flat or tapered beams
- ▶ Meets ASME B30.16 for use with powered or manual hoists
- ▶ Each unit is serialized, supplied with a test certificate and manual
- ▶ Metric rated for vertical lifting at 2,200 lb per ton

Model	Capacity metric tons	Weight lb	Beam Width					
			A	B	C	D	E	F
BC-1	1	4	2-15/16" – 9-1/16"	3-3/16"	8-3/4"	4" – 6-5/16"	1-1/8"	13/16"
BC-2	2	5	2-15/16" – 9-1/16"	3-5/8"	8-3/4"	4" – 6-5/16"	1-1/8"	7/8"
BC-3	3	9	3-5/32" – 12-5/8"	4-5/8"	10-3/4"	6-5/8" – 9-1/2"	2-7/16"	15/16"
BC-5	5	11	3-9/16" – 12-5/8"	4-13/16"	10-3/4"	6-5/8" – 9-1/2"	2-3/8"	13/16"
BC-10	10	11	3-9/16" – 14-3/8"	5-15/16"	11-1/64"	6-11/16" – 9-1/4"	1-31/32"	1-37/64"

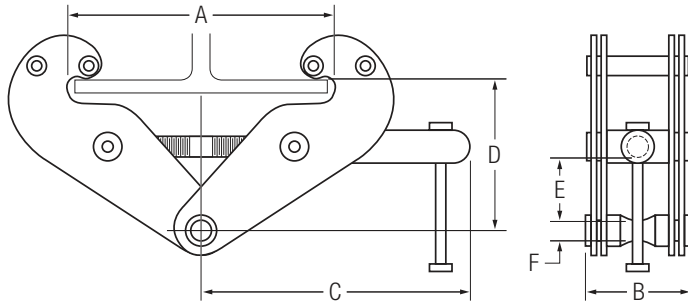



Distributed by:



Ingersoll Rand (NYSE:IR) advances the quality of life by creating and sustaining safe, comfortable and efficient environments. Our people and our family of brands — including Club Car®, Ingersoll Rand®, Schlage®, Thermo King® and Trane® — work together to enhance the quality and comfort of air in homes and buildings; transport and protect food and perishables; secure homes and commercial properties; and increase industrial productivity and efficiency. We are a \$14 billion global business committed to a world of sustainable progress and enduring results.

[Ingersollrandproducts.com](http://Ingersollrandproducts.com)